

**YANMAR**

OPERATOR'S MANUAL

# DIESEL TRACTOR

EF494T

en Original instructions

# SAFETY



## WARNING

**Never attempt to operate or service this machine until you have first read and understood all of the applicable Safety Instructions that are set forth in this Manual.**

**The failure to comply with all relevant Safety Instructions could result in bodily injury.**

## TO THE OWNER

This instruction manual describes how to maintain your tractor in good condition and how to operate it safely and correctly. Please read this manual carefully before using the tractor. Keep this manual close to your tractor, after you have read through it. If you lose or damage this manual, ask your YANMAR dealer for a new manual right away.

### IMPROVEMENT

Sometimes parts are changed to improve or upgrade the features of the tractor, or for other reasons. Therefore, the parts shown in this manual may not apply to your tractor.

#### Note:

- All data are subject to change without prior warning. Some illustrations and photographs may show optional accessories.
- A Roll-over Protective Structure (ROPS) is optional.

## SYMBOLS USED

### 1. Safety-alert Symbol

This is the safety-alert symbol. When you see this symbol on your tractor or in this manual, be alert to the possibility of personal injury and carefully read the messages that follow.



### 2. Signal Words

The signal words "DANGER" "WARNING" "CAUTION" are used with the safety-alert symbol.

- (1) "DANGER" indicates an imminently hazardous situation which, if not avoided, will result in death or serious injury.
- (2) "WARNING" indicates a potentially hazardous situation which, if not avoided, could result in death or serious injury.
- (3) "CAUTION" indicates a potentially hazardous situation which, if not avoided, could result in minor or moderate injury.



### 3. Service instructions

- (1) This stop symbol indicates important proper operation or service messages in this manual. When you see this symbol, carefully read the messages that follow.
- (2) "NOTE" describes precautions to take while working.



**IMPORTANT  
NOTE**

### 4. Measurements

This tractor is of metric design. All hardware are therefore metric (ISO). Make sure to use the specified metric hardware when service becomes necessary.



### 5. Direction

Right-hand and Left-hand sides of the tractor are determined by facing in the direction of the tractor forward travel.

## TABLE OF CONTENTS

SAFETY INSTRUCTIONS	1
AFTER SALES SERVICE AND WARRANTY	15
After sales service	15
Availability of spare parts	15
PART NAMES	19
SAFETY LABEL LOCATION	21
FUNCTION OF EACH CONTROL	22
Engine	22
Traveling, PTO related functions	23
Hydraulic system	26
Others	29
PRE-OPERATION CHECKS	30
1. Pre-operation checks	30
2. Breaking in the engine (first 50 hours)	34
3. Starting and stopping engine	34
4. Raising or lowering implement	36
5. Adjusting lowering speed for implement	36
6. Starting and stopping	37
7. Traveling on the load	38
8. Traveling on the slope	39
9. Power steering	39
10. Driving in and out of Fields	40
11. Setting an adequate speed	40
12. Turning in a field	41
13. Position control	41
14. Using differential lock	41
15. Loading and unloading	42
16. Adjusting wheel tread	42
17. Hydraulic output	44
18. Using 3-point link	45
19. Adjusting top link	46
20. Mounting general farm implements	47
21. Notes on using service implement	48
22. Using PTO shift lever	49
23. Using drawbar hitch	49
24. Safety frame (ROPS)	50
AFTER OPERATION	51
1. After operation	51
2. Opening the bonnet and side covers	51
3. Checking and supplying fuel	52
4. Care for long period of storage	53
PERIODIC INSPECTION AND ADJUSTMENT	54
1. Check intervals	55
2. Oil and grease	56
3. Oil and water volume	56
4. Replacing oil	56
5. Replacing oil filter elements	58
6. Engine coolant	59
7. Fuel line	60
8. Replacing radiator screen and air cleaner elements	61
9. Checking battery	62
10. Checking fluid lines	63
11. Checking electrical wiring	63
12. Greasing	64
13. Adjusting brake	67
14. Adjusting clutch	68

15. Adjusting steering wheel	68
16. Adjusting fan belt	69
17. Adjusting tow-in	69
18. Replacing fuse	70
19. Checking tires	71
20. Color of exhaust gas	71
<b>TROUBLESHOOTING</b>	<b>72</b>
1. Engine parts	72
2. Clutch, brake and related parts	73
3. Hydraulic system	73
4. Electric system	73
<b>SPECIFICATIONS</b>	<b>74</b>
<b>IMPLEMENT CAPACITIES</b>	<b>75</b>

**! SAFETY INSTRUCTIONS**

**! DANGER**

Read these instructions carefully. Important instructions are given for the safe operation and servicing of the tractor. Failure to follow these instructions is likely to result in an accident involving death or serious injury.

**STUDY THE TRACTOR AND IMPLEMENTS**

Do not permit anyone unfamiliar with the tractor or the operations of its implements to use the machine. The operator's manual should be considered a permanent part of the tractor and should remain with the tractor.

Know the positions and functions of all controls and the meaning of any identification symbols on your controls, gauges, and indicators before attempting to operate the tractor.

Know how to stop the engine in an emergency.

Make sure you understand the capabilities, operating characteristics and limitations of the tractor and implement, such as maximum ballast weight, hydraulic lifting capacity, speed, turning radius, operating clearances etc.

Do not add extra ballast weight to compensate for a load that is too heavy.

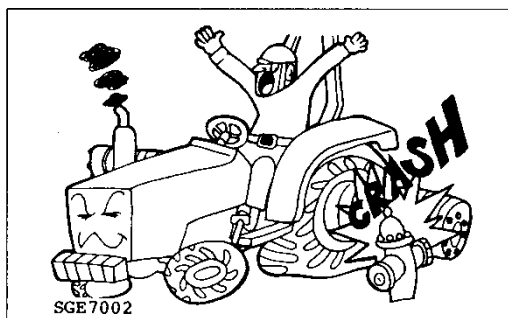
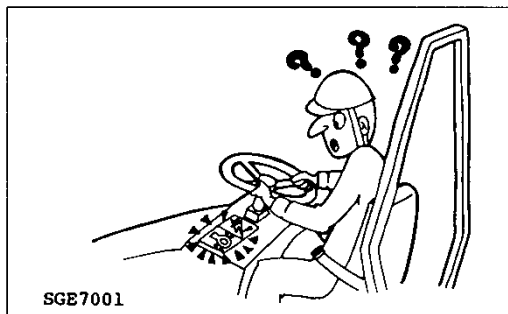
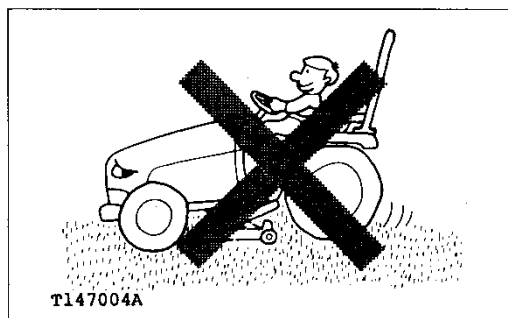

## PROTECT OPERATOR SAFELY

Install an approved Roll-over Protective Structure (ROPS) for safe operation. If a tractor rolls over without a ROPS, death or serious injury is likely.

Always fasten the seat belt while operating the tractor with Roll-over Protective Structure (ROPS) up.

Do not use the seat belt if the foldable Roll-over Protective Structure (ROPS) is in the folded position or the tractor does not have the Roll-over Protective Structure (ROPS).

Extreme caution is required when operating a tractor around trees or other overhead obstructions, such as guy wires or power lines. Interference between the ROPS and these obstructions may cause the tractor to tip backwards.

Do not modify any structural portions of the ROPS by welding, bending, grinding or cutting them. If any component of the ROPS is damaged or involved in a rollover incident, replace it with a complete new cage. Do not attempt to repair the original one. Damaged or modified structural parts impair the strength of the ROPS and may lead to injury.

Avoid loose fitting or baggy clothing, torn clothing, bulging pockets, frayed edges or heavy cuffs. Loose frayed and bulky clothing can easily become entangled in rotating parts. Wear work clothes and work shoes or boots. Also you may need a: **SAFETY HELMET, SAFETY SHOES, EYE PROTECTION, HEAVY DUTY GLOVES, HEARING PROTECTION, REFLECTIVE CLOTHING, OR A RESPIRATOR/FILTER MASK.**

Wear whatever safety gear and clothing is necessary for the job.

Prolonged exposure to loud noise can cause impairment or permanent loss of hearing. Wear a suitable hearing protective device such as ear protectors or earplugs to protect against objectionable or uncomfortable noise.

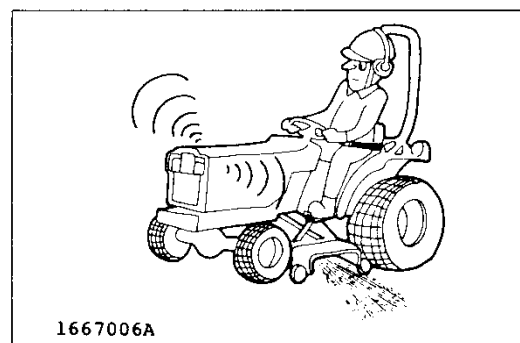
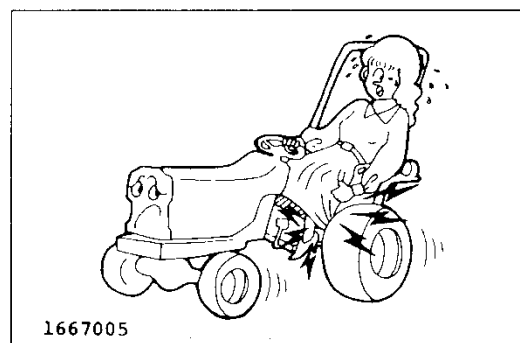
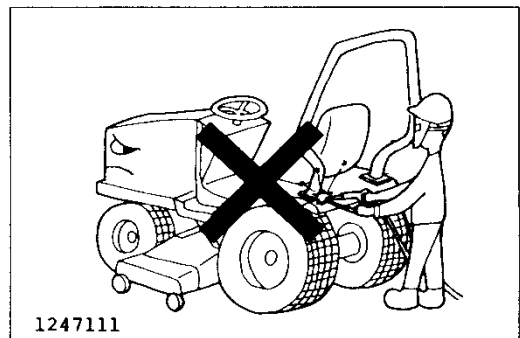
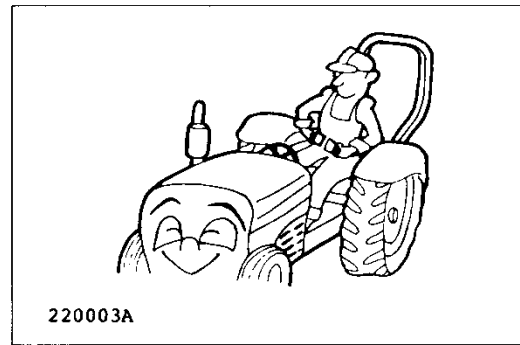

## BEFORE OPERATING

Do not operate the tractor when tired, sick, sleepy, drunk, feeling overworked, taking medicine, pregnant, suffering from mental disease or if other improper conditions are present. These conditions impair a person's skill and judgment. When you begin feeling tired while operating the tractor, take a 10-minute break to stretch, walk about, lie down or snack. Do not continue if you still feel tired after taking a break.

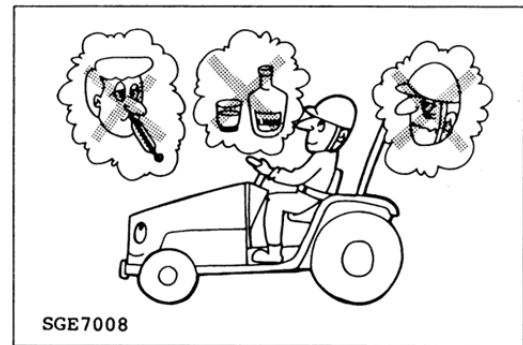

Remove oil, grease or mud from the hand rails, steps, pedals, controls, and floor to avoid slips or loss of control.

In winter, scrape off any ice or snow on the handrails, steps, pedals, controls, and floor.

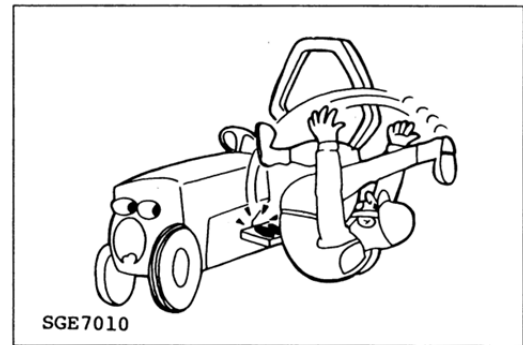

To attach or remove an implement, refer to the implement and tractor manufacturer's manuals for the proper procedures.

To unhitch an implement, move to a level area, lower the implement to the ground and then block the equipment in position before unhitching. If an implement has wheels, block them to prevent it from rolling.

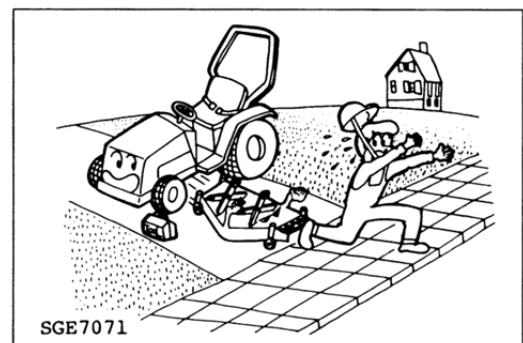

### Make sure

- (1) The tractor and implements are in good condition and properly adjusted.
- (2) To check for loosened bolts, adequate lubricants, damaged or under-inflated tires, safety shields and devices, steering and braking linkages, hydraulic leaks, etc. Refer to this manual for more detailed information.
- (3) That implements are properly attached and hooked up. Check that the PTO U-joint yoke and locking devices are securely latched on their shafts.
- (4) That the tractor's PTO speed matches the implement's specifications.

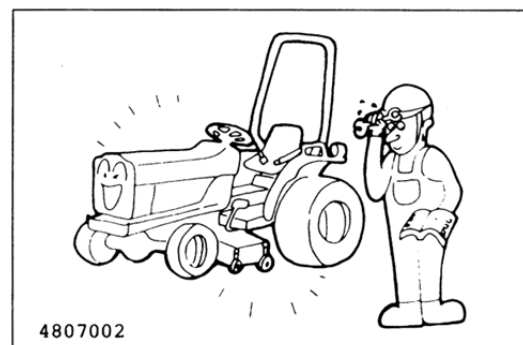



## STARTING

### START THE ENGINE SAFELY

If you operate the engine inside a closed building, be sure there is plenty of ventilation before starting the engine. Exhaust fumes are poisonous. Carbon monoxide is especially dangerous because it is odorless and colorless. You can easily be overcome without realizing it.

Always stay near the tractor and keep the parking brake set securely while warming it up.

Only start the engine from the operator's seat. Never start the engine while standing on the ground.

Before you start the engine:

- (1) Sit in the operator's seat and adjust the seat position if necessary.
- (2) Make sure the ROPS is in working condition and seat belt securely fastened.
- (3) Lower any implement to the ground.
- (4) Place speed shift lever and the PTO switch in neutral.
- (5) Set the parking brake.
- (6) Disengage the PTO for the neutral position.
- (7) Check all the instruments, gauges and indicator lights.
- (8) Be sure everyone is clear of the tractor and implement.

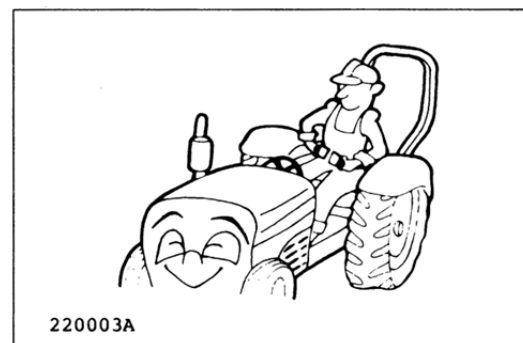
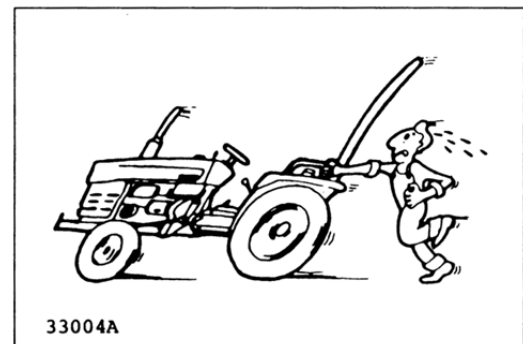
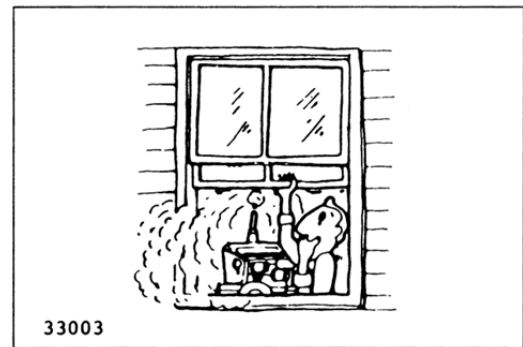

## DURING OPERATION

### OPERATE THE TRACTOR SAFELY

Keep people and pets a safe distance away when starting and operating the tractor and implement.

Do not permit any person other than the operator to ride or board the tractor or implements, including any wagons.

Do not play games with the tractor.  
Never allow children to ride on your lap.

Do not touch the muffler, radiator, engine or other high temperature parts before they have cooled down completely.

Do not try to get on or off a moving tractor or implements. Always use the handrails and steps and face the tractor when getting on and off. Never use control levers as a handhold and never step on foot controls when getting on and off. Do not get on the tractor with wet or greasy hands, or muddy shoes. Do not jump off the tractor. Be aware of slippery conditions on the ground.

Make sure you check the connecting points on your equipment.

Keep hands, feet and clothing away from power-driven parts. Keep others away from articulated joints, hitches, drawbar, lift arms, PTO drives, cylinders, and anything else that moves.

Never stand, or allow anyone else to stand, between the tractor and an implement, unless the engine is turned off and the parking brake is engaged securely.

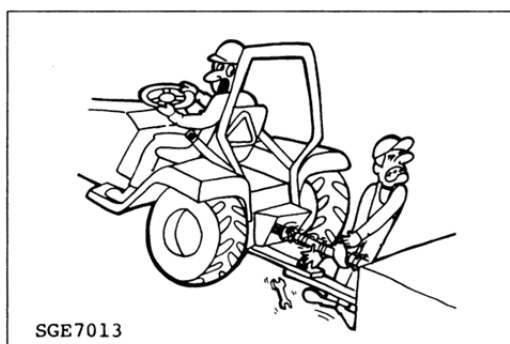
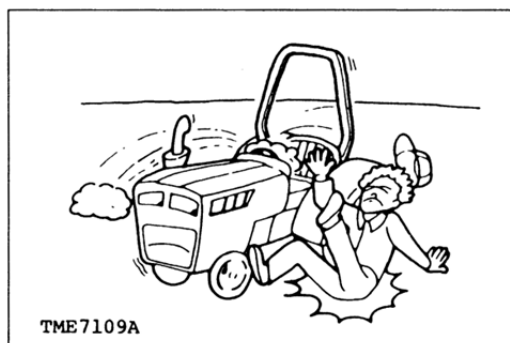
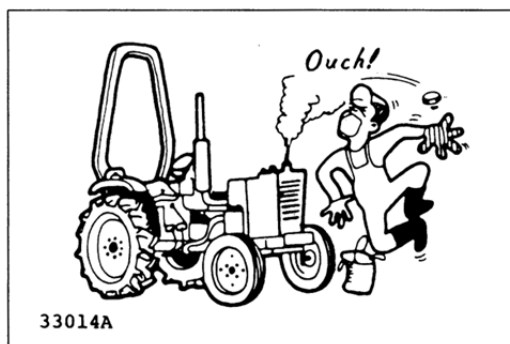
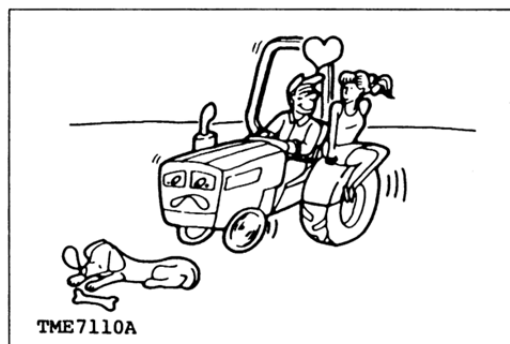

**OPERATE THE TRACTOR SAFELY (continued)**

Oversized implements are dangerous for tractor operation and are not safe for you. Refer to the implement's operator manual for the minimum and maximum horsepower requirements and weights that are allowed.

When using a heavy implement in front, always install ballast or an implement on the rear for safe, stable steering control.

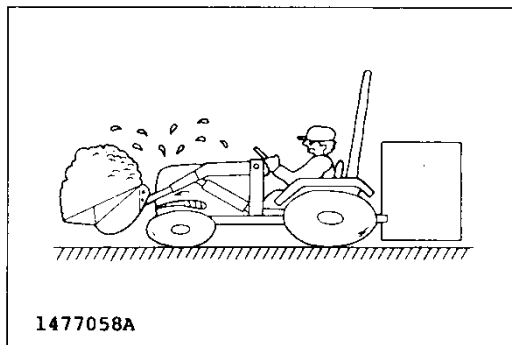

When using a heavy implement on a rear 3-point hitch, always install ballast or an implement on the front for safe, stable steering control.

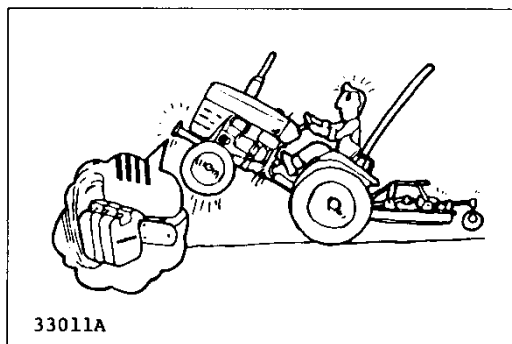

Slow the tractor down when crossing rough ground, tall grass or weeds. Rocks, holes and stumps may be hidden in the brush.

Do not let your tractor bounce. You may lose steering control.

Never use the tractor to round up farm animals.



**Do not allow the tractor to coast downhill with the clutch in, or with the gear shift in neutral.**

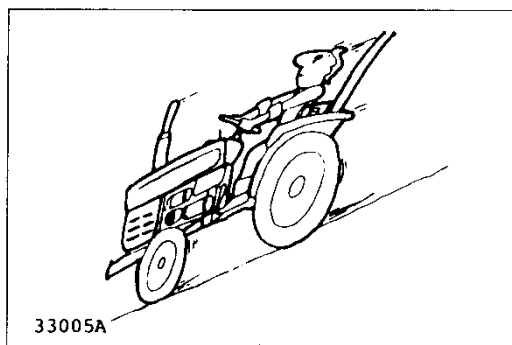

When operating the tractor on a slope, set the wheel tread as wide as possible for maximum stability, reduce the engine speed and avoid quick application of the brakes or sharp turns.

Stay off hills and slopes which are too steep.

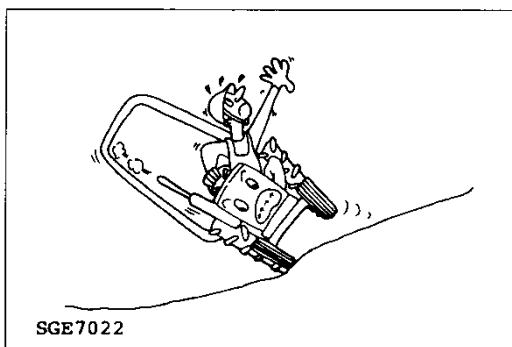

## AVOID TIPPING OVER

When starting the tractor on an uphill slope, shift to as low a gear as possible and reduce the engine speed to avoid tipping over backward.

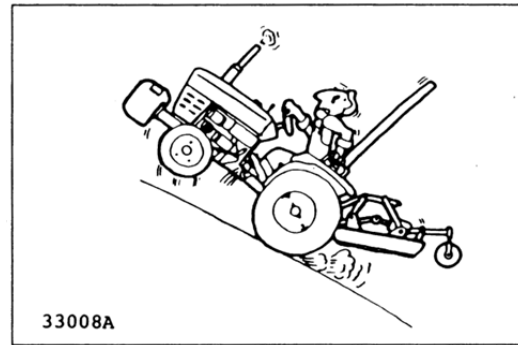

Do not drive near the edge of a gully or a steep embankment. Avoid holes, ditches, etc. which may cause the tractor to tip over, especially on hillsides or steep slopes.

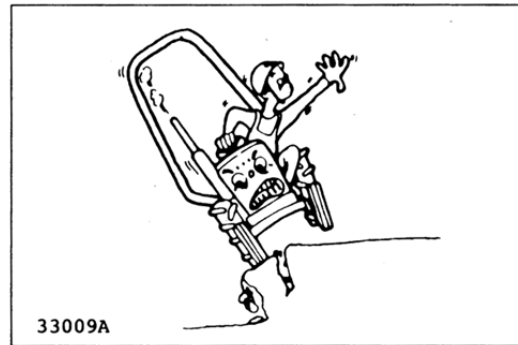

When operating on slopes or rough uneven ground, it is important to have as much distance as possible between the wheels. Operate the tractor carefully at the lowest speed.

Do not pull carts etc. from the top link or the top link hinge, rear axle, or any point above the drawbar. Doing so could cause the tractor to tip over backward. Only attach items to be pulled to the drawbar.

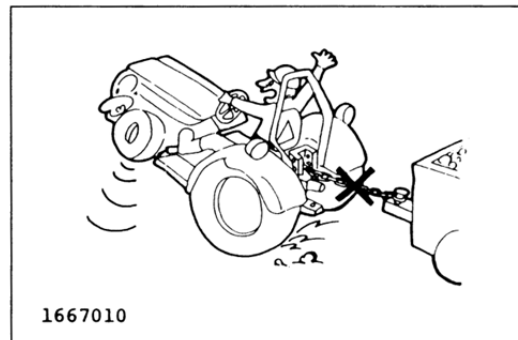

Use care when pulling loads or installing a heavy implement.

- (1) Only use approved hitch points.
- (2) Limit loads to those which you can control safely.
- (3) Limit travel speeds so that you can control the tractor safely.
- (4) Do not turn too quickly.
- (5) Use care when backing up.
- (6) Install the amount of ballast recommended in the operator's manual.

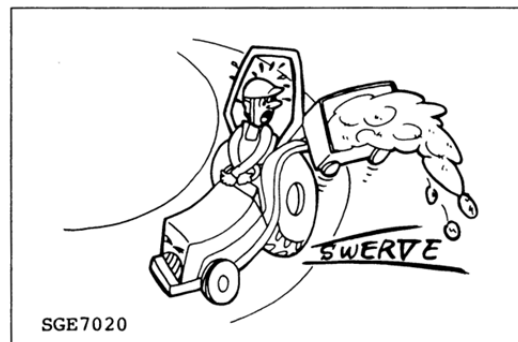

Driving forward out of ditch or in muddy conditions, or up a steep slope, could cause the tractor to tip over backward. If the mud is deep enough it will keep the wheels from turning. Then, the tractor will rotate up and back around the axle very quickly. When stuck in muddy conditions, do not remove the implement or ballast weight. Always back out.

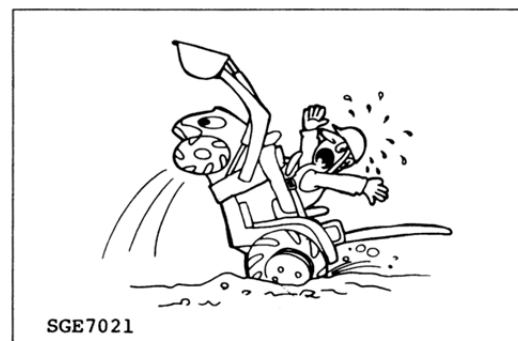

**STAY CLEAR OF THE PTO**

The PTO shaft safety guard (A) should be installed when the PTO system is not in use.

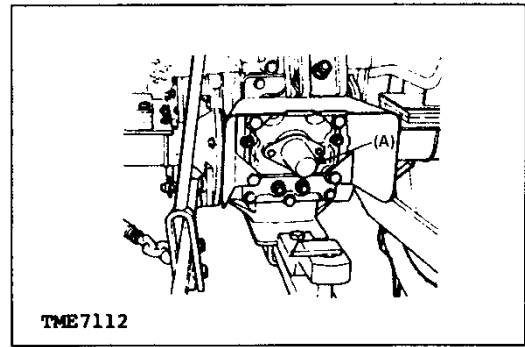

Make sure that the tractor PTO speed matches the implement's required PTO speed.

Do not drive or operate the implement beyond the tractor's PTO speed.

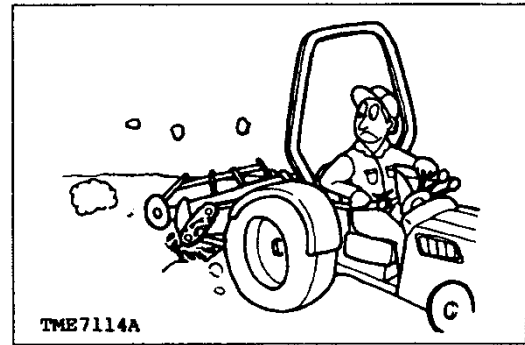

Stop the engine and be sure the PTO has stopped moving before:

- (1) Connecting or disconnecting the PTO shaft.
- (2) Making any adjustment to the PTO drive or 3-point hitch.
- (3) Adjusting, cleaning or servicing PTO driven implements.

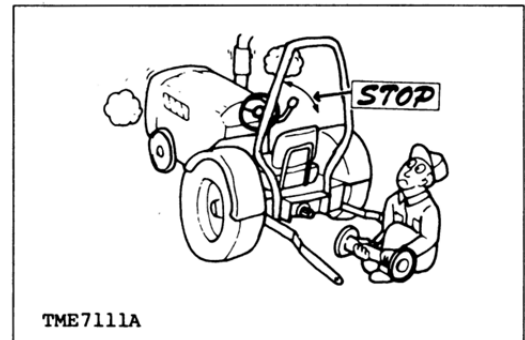

## TRANSPORTING

Raise all implements and place them in the locked-for-transport position.

Do not drive the tractor on the road with implements in motion.

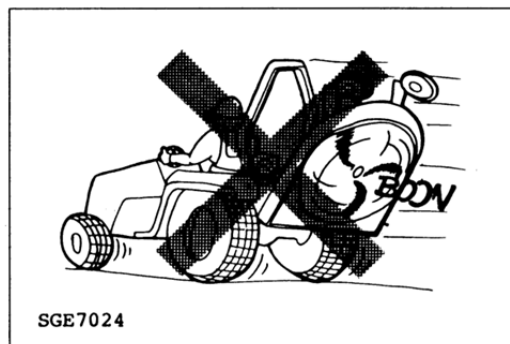

Couple the brake pedals together for travel at road speeds. (This only applies to models with two brake pedals.)

Do not make sharp turns at road speeds.

Always dim your headlights when another vehicle is coming toward you. Keep the lights adjusted so that they will not blind the driver of another vehicle.

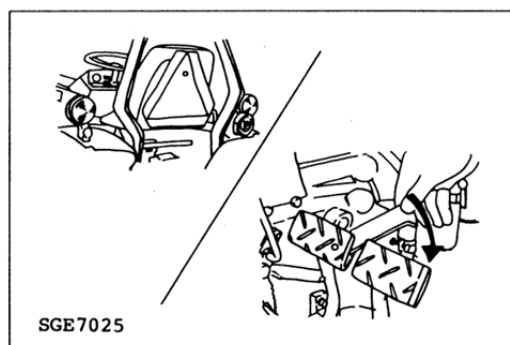

Before going down a steep hill, shift to the lowest speed in order to control tractor with the least braking possible. Do not coast downhill.

Do not stop or start suddenly when going uphill or downhill.

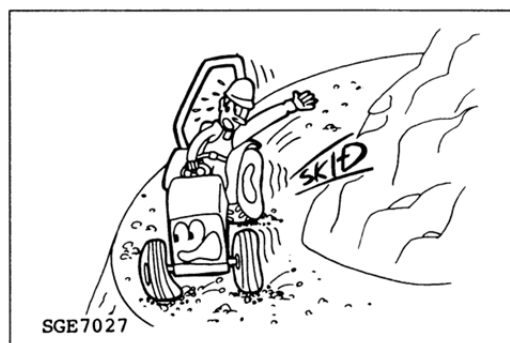

When loading (or unloading) the tractor onto a vehicle, use care as follows:

- (1) Use a strong loading ramp or loading dock.
- (2) Use the lowest reverse speed and drive up the loading ramp backward.
- (3) Set the parking brake and place wheel blocks firmly under the vehicle's wheels.
- (4) Do not try to drive onto a trailer from the bank of a ditch.

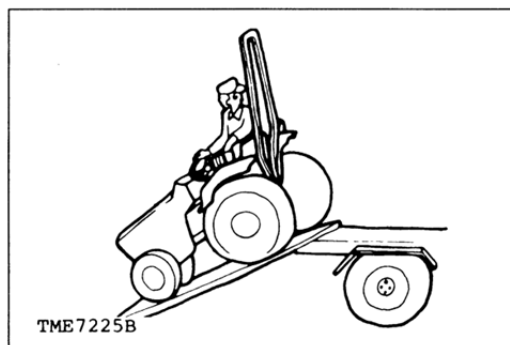

Secure the tractor and any other load with chains. Be sure they are tight.

If chains are not available, use rope, wire, blocks, or a winch cable. Check the load after traveling a few kilometers, and every 100 km thereafter, to make sure that the ties are not coming loose. Also, check after rough bumps in the road.

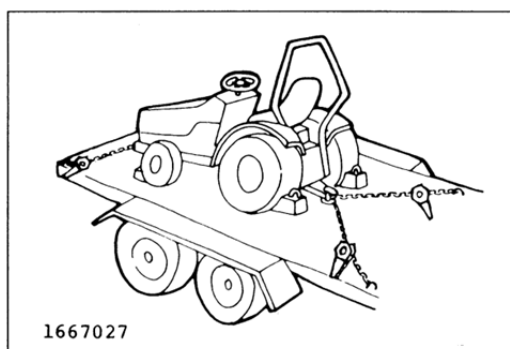

## TOWING

When towing a load that weighs more than the tractor, the trailer should have its own brakes. When towing, drive slowly, avoid hills and apply the brakes gently.

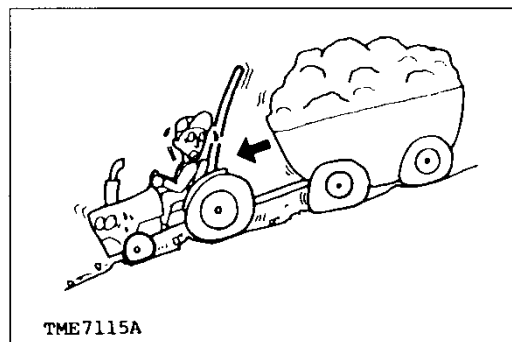

A safety chain will help control an implement being pulled if it accidentally separates from the drawbar while traveling. Using appropriate adapter parts, attach the chain to the tractor drawbar support or to some other specified anchor location. Leave only enough slack in the chain to permit turning.

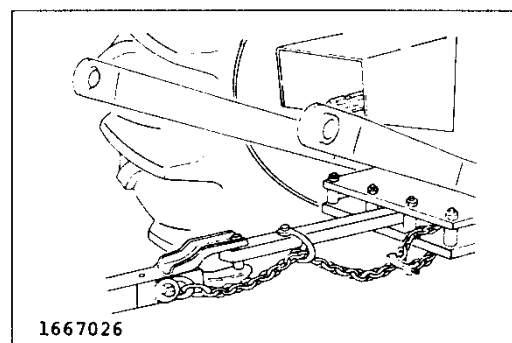

Do not tow the tractor faster than the tractor's maximum travel speed in the highest gear, and never more than 25 km/h (16 mph).

Check local regulations concerning towing. Towing is illegal in some countries.

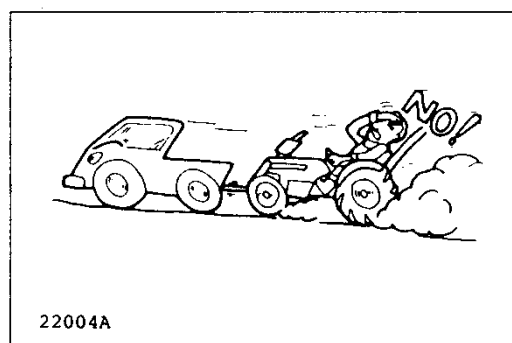

## AFTER THE DAY'S OPERATION

### PARK THE TRACTOR SAFELY

Park tractor on a firm level surface.

When parking the tractor, couple the brake pedals together and set the parking brake securely. When you must park on a slope, position the tractor at a right angle to the slope and set the parking brake securely. Then, block both the front and rear wheels.

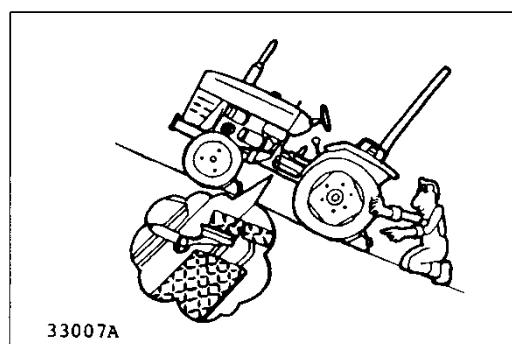

Take all possible precautions as follows when leaving tractor unattended:

- (1) Disengage the PTO and lower any implement to the ground.
- (2) Move all shift levers to neutral.
- (3) Couple the brake pedals together and set the parking brake lever.
- (4) Run the engine for 2 to 3 minutes at one-third throttle speed and no load in order to cool it.
- (5) Stop the engine and remove the key.
- (6) Cycle the hydraulic controls to eliminate any residual pressure.

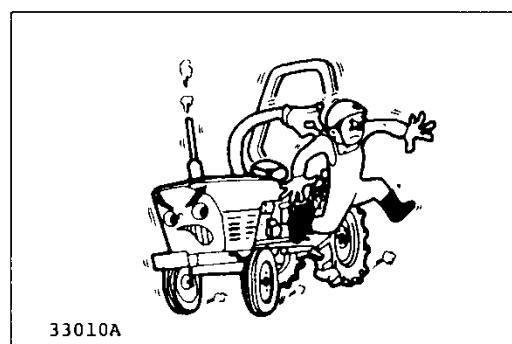

## MAINTENANCE AND SERVICE

### AVOID EXPLOSIONS OR FIRES

Refuel the tractor when the engine is cool and in a well-ventilated area, preferably outside.

Never fill the fuel tank with the engine running.

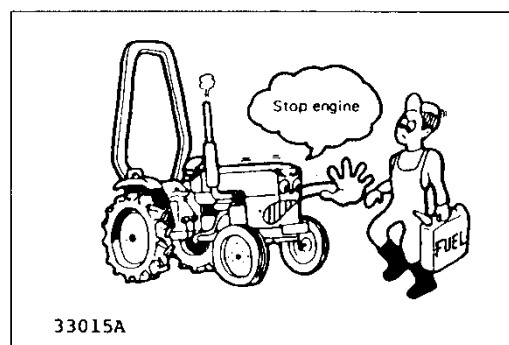

Be sure to use the correct type and grade of fuel.

Keep all sparks, flames and smoking materials well away while handling fuel.

Ground the fuel funnel or nozzle against the filler neck on the tractor to prevent sparks.

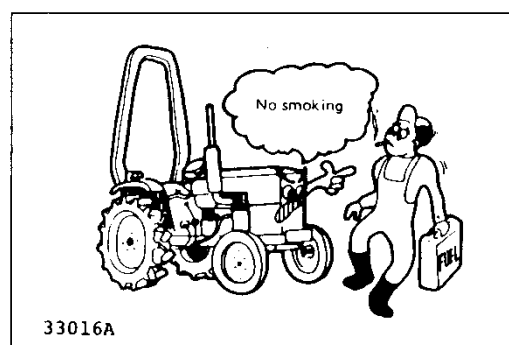

Do not overfill the tank or spill the fuel. If fuel is spilled, wipe it up immediately. Install the fuel tank cap securely after refueling.

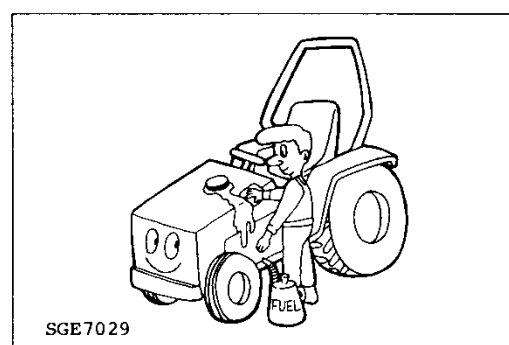

Be sure there is plenty of ventilation before charging the battery. Gas produced while charging the battery is explosive.

Keep all sparks, flames, and smoking materials well away from battery. Hydrogen gas at a concentration as low as 7 per cent can explode in the presence of a spark or open flame and spatter acid.

Use a flashlight to check the battery electrolyte level. Never use an open flame or match to check.

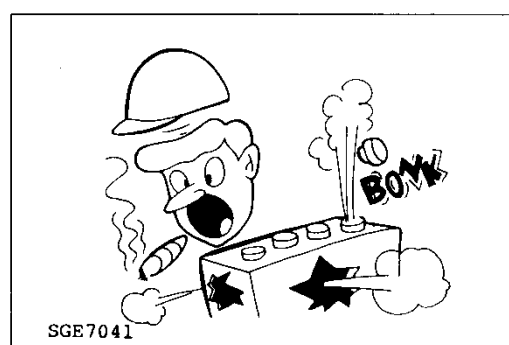

Keep the engine clean and free of grass, leaves, or excessive grease.

Let the engine cool down before storing the tractor in an enclosure or covering it with a sheet.

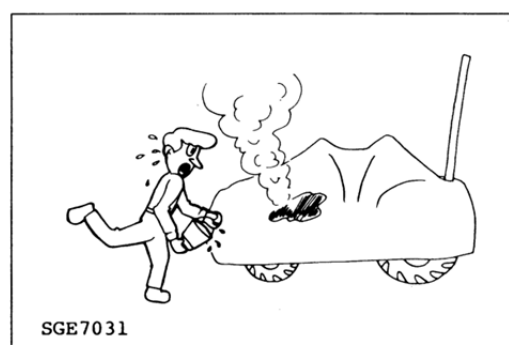



## MAINTENANCE AND SERVICE (continued)

Do not service the tractor while it is in motion or while the engine is running.

Before servicing the tractor, always set the parking brake, block the wheels, lower the implement, release all hydraulic pressure and place all the controls in neutral.

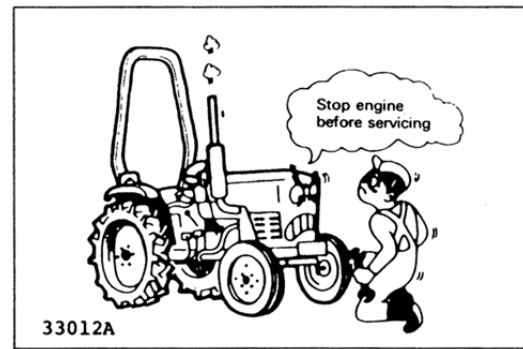

Use only the correct tools and equipment.

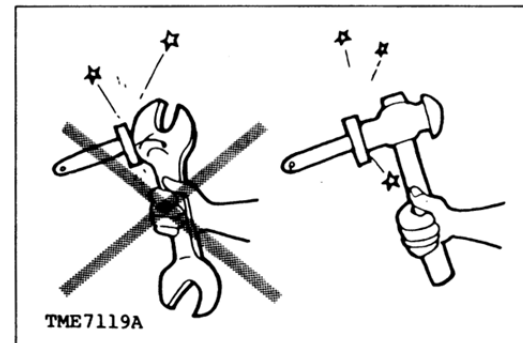

Unauthorized modification to the tractor may impair its function, create an unsafe situation and reduce the tractor's useful working life.

Do not use substitute parts that may not meet the strength and design requirements or may not fit the tractor.

Do not use repair parts not approved by YANMAR.

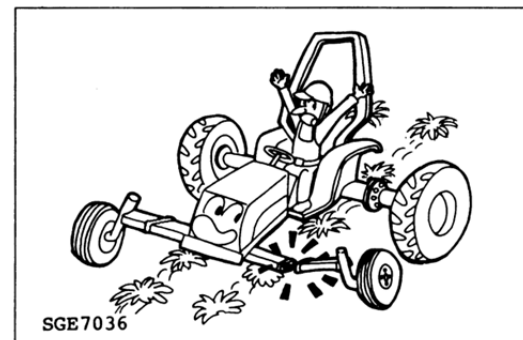

Remove the radiator cap only when the coolant temperature is low. Wait at least one hour after operation, to allow the coolant to cool down.

Cover the radiator cap with a cloth before opening it and release the pressure gradually before completely removing the cap.

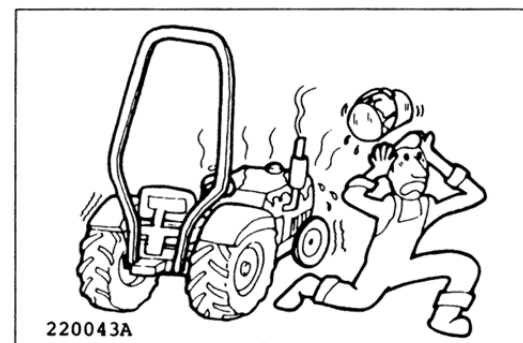

Do not service the hydraulic system when the hydraulic oil is hot.

Do not set the relief valve pressure higher than stated in the tractor or implement specifications.

Do not close off the overflow or bypass lines.

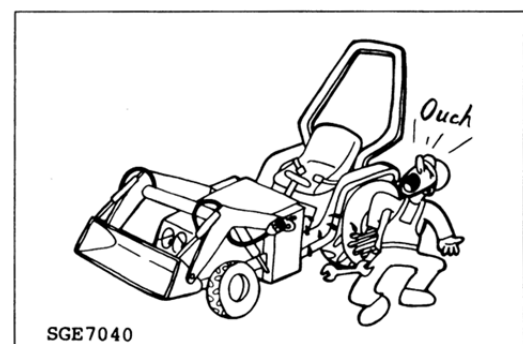

## MAINTENANCE AND SERVICE (continued)

Hydraulic oil or diesel fuel escaping under pressure can penetrate the skin and cause serious injury. Before disconnecting any lines, be sure to relieve all pressure. Before applying pressure, be sure all connections are tight and all components are in good condition.

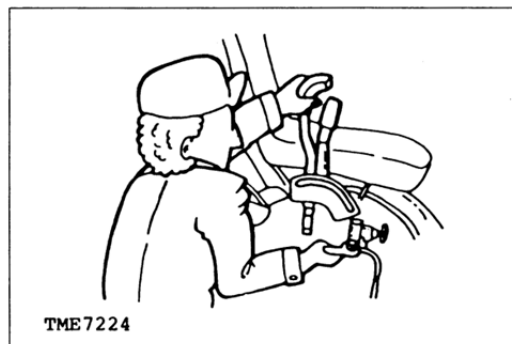

Fluid escaping under pressure from a very small hole can be almost invisible. Wear safety goggles for eye protection and use a piece of cardboard to check for suspected leaks. Do not use your hands. If injured by escaping fluid, see a doctor at once. Serious infections and other problems can develop if proper medical treatment is not administered immediately.

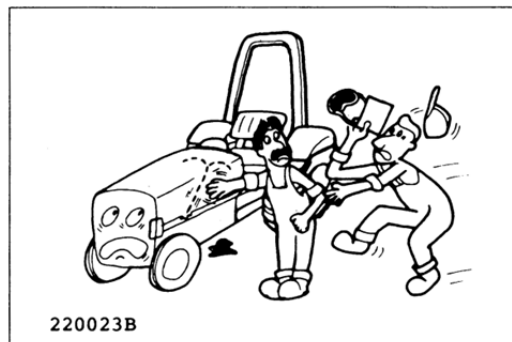

Disconnect the battery ground cable before working on the electrical system or working in any area where you might come into contact with electrical components. Disconnect the ground cable first and reconnect it last.

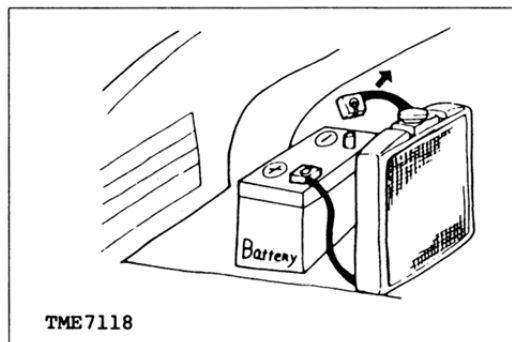

The sulfuric acid in a battery is poisonous. It can destroy clothing and burn the skin. Wear eye protection and rubber gloves when filling the battery. If you spill acid on yourself, flush your skin with water and apply baking soda or lime to neutralize the acid. Then seek medical attention right away. If acid is swallowed, get medical attention immediately!

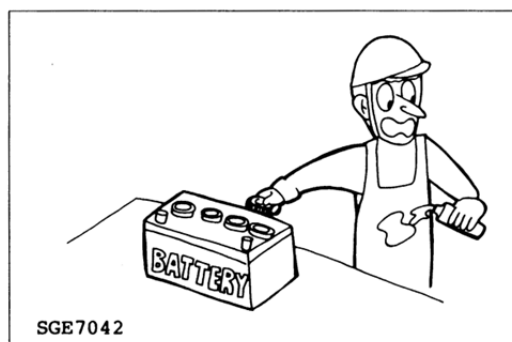

## Storage

Whenever the tractor will not be used for a few months, do the following:

- (1) Drain the fuel tank.
- (2) Lower any implement still attached.
- (3) Set the parking brake and block the wheels.
- (4) Remove the battery and store it in a cool, dry place, out of the reach of children.

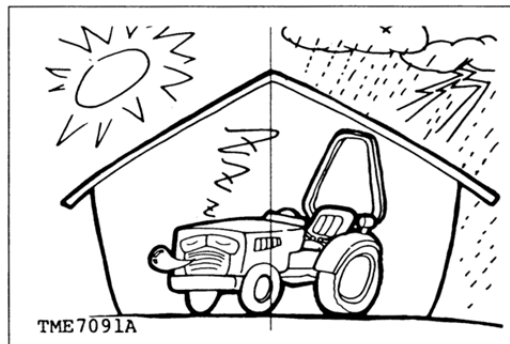

## CAUTION

### ALWAYS BE ENVIRONMENTALLY RESPONSIBLE

- Follow the guidelines of the governmental agency for the proper disposal of hazardous materials such as engine oil, diesel fuel, engine coolant and, machine fluid, grease.
- NEVER dispose of hazardous materials irresponsibly by dumping them into a sewer, on the ground, or into groundwater or waterways.
- Failure to follow these procedures may seriously harm the environment.
- Comply with legal regulations and guidelines for disposal of: empty containers for fuel, cooling water (coolant), oil, grease; fuel/oil filters; batteries; machine itself; machine accessories; and packaging materials.

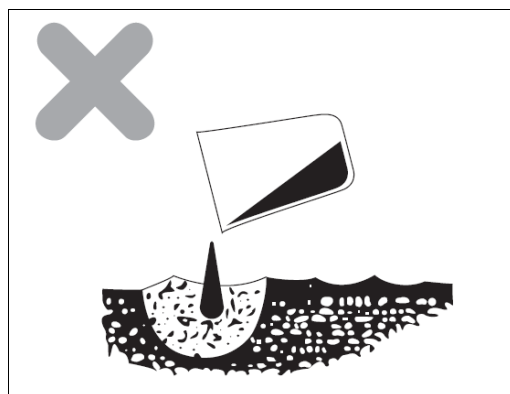

## AFTER SALES SERVICE AND WARRANTY

### After sales service

If your tractor is not working normally, refer to the troubleshooting section in this manual. You can also consult with your service representative.

Information needed when asking for service:

- Model name and serial number (A) of your tractor.
- Engine type number (B)
- Operating conditions. What type of work was being performed when the problem occurred?
- How long have you used your tractor? (total hours of operation)
- Any other information about the problem that has occurred.

### Availability of spare parts

Maintenance parts and spare parts will be available for 10 years after the production of this tractor series has been discontinued. However, special parts will be available subject to consultation. Yanmar may be able to supply a particular part after the normal supply period.

- (A) Tractor serial number
- (B) Engine type number

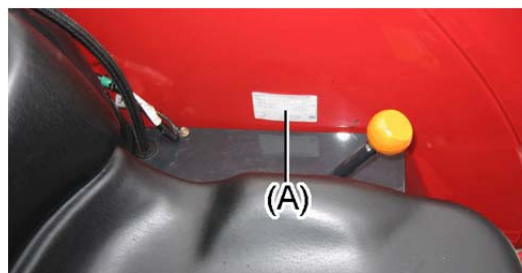

(A)

MODEL	□□□□□□
ENGINE DISPLACEMENT	□.□□□ L
ENGINE OUTPUT	□□□ HP/□□□□ RPM
SERIAL NO.	□□□□□□

**YANMAR**  
 YANMAR CO., LTD.  
 ASSEMBLED IN THAILAND FROM JAPAN MAIN COMPONENTS

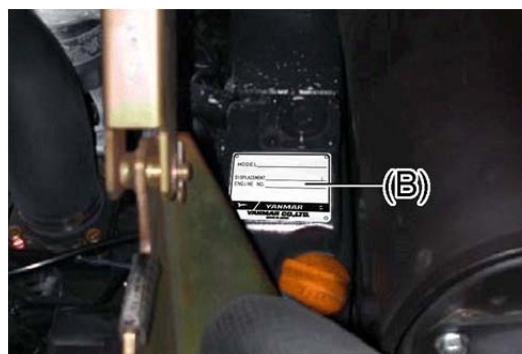

(B)

MODEL	_____
DISPLACEMENT	_____ L
ENGINE NO.	_____

**YANMAR**  
**YANMAR CO., LTD.**  
 MADE IN JAPAN

### PURPOSE OF THIS MACHINE

This machine is designed to be operated with a various implement for particular tasks and for pulling a trailer in a variety of agricultural operations. Other use or modification is prohibited.

### Orientation and Position Marks

A right-hand and Left-hand side of the machine is determined by facing in the direction of the machine forward travel.

**FUSE BOX**

(1) The alternator fuse (60A) and main fuse (60A) are of slow blow type. When any of these has been blown, contact your local YANMAR dealer.

(A) Main fuse: 60A

(B) Alternator fuse: 60A

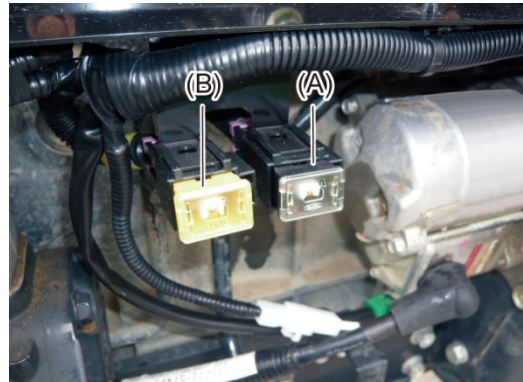

(2) The electrical fuses are in the engine compartment. Use of fuse other than a correctly rated one way may cause damage to the electrical system. Replace the blow fuse with a new fuse of the same amperage rating.

- START : Starter motor      5A
- WORK : Working light      5A
- TURN : Turn signal light   5A
- TAIL : Tail light            5A
- HEAD : Head light          15A
- HORN : Horn                  5A
- FUEL : Fuel pump            5A
- ENG : Timer relay            5A
- IND : Indicator light        5A

START	WORK	TURN	TAIL	SPARE	SPARE	1A7780-65470
5A	5A	5A	5A	5A	15A	
HEAD	HORN	FUEL	ENG	IND	PULLER	
15A	5A	5A	5A	5A		

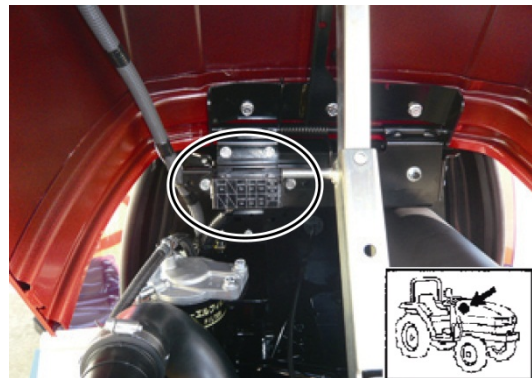

## WARNING

You must carefully note the length of the bolts when you install Yanmar recommended implements and equipment behind the transmission case.

1. First, it is necessary to measure the thickness of the parts. Then use bolts whose length includes the extra measured thickness.
2. When the original part is removed and a different part is installed, it is necessary to measure difference in thickness of the two parts and change the length of the bolts appropriately.

If you don't use appropriate consideration of these issues, you will damage the transmission case and create a dangerous situation.

### Reference

The bolt length "B" in the case must be 2.0 times the diameter of "A".

For casting metal cases, rear axles, etc.,  
The bolt length "B" in the case must be 1.5 times the diameter "A".

D: Transmission case

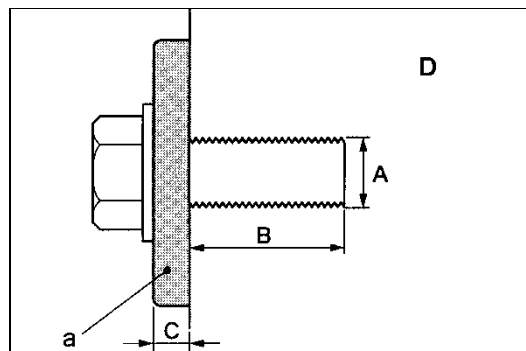
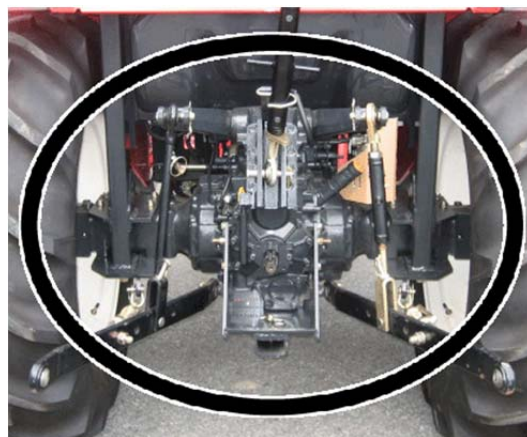

Aluminum cases

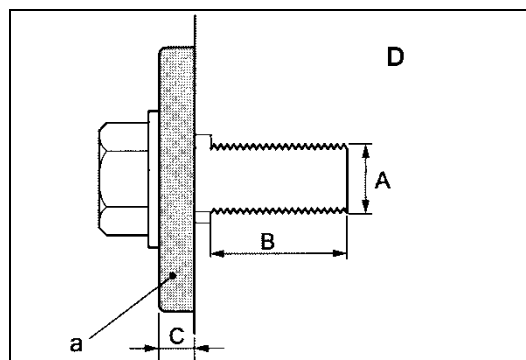

Cast metal cases

When you install part "a" behind the transmission case, use bolts whose length includes measurement "C".

## CAUTION

- Do not try to adjust engine speed adjuster screw (A) located on engine fuel injection pump. Any accident or failure resulting from adjusting the screw would not be covered by Yanmar's guarantee.
- Do not try to unseal and adjust engine fuel injection pump (B). Any accident or failure resulting from adjusting the pump would not be covered by Yanmar's guarantee.

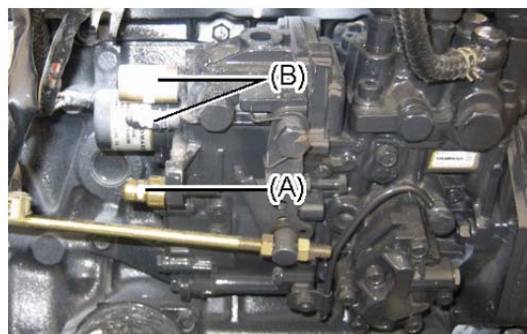



## WARNING

- Do not move the tractor if the wheel mounting bolts or nuts are loose. If the tractor is driven with loose nuts or bolts, there is a possibility that an accident will occur.
- Make daily and periodic wheel inspections to check for loose nuts and bolts on the wheels. If they are loose, retighten them to the specified torque.



## IMPORTANT

The first 50 hours of handling and maintenance greatly affect the service life and performance of a new tractor. In particular, pay special attention to the following points during this period of time.

- (1) Refrain from sudden acceleration and sudden braking.
- (2) Do not increase the speed too much or carry any more load than is necessary.
- (3) Operate the tractor only after the engine has warmed up sufficiently.
- (4) Slow down on a rough road or on a slope.
- (5) Check the tightness of the wheel mounting bolts after the first 10 hours and again after the first 50 hours. If they are loose, retighten them. (For specific tightening torques, refer to the table in the instruction manual.)



## IMPORTANT

When the tractor gets stuck in a muddy portion in field, do not tie a piece of lumber, log or pipe to the front or rear wheels to drive out of the muddy portion. It may break transmission and/or rear axle inner parts or cases.

Put a ladder bridge under the wheels and then drive out. Or use strong rope or chain to pull it out of the muddy portion slowly by the other tractor or so.



**Note:**  
These photos show rear tire with cage wheel.

## PART NAMES

- |                         |                                       |
|-------------------------|---------------------------------------|
| (1) Bonnet              | (10) Rear wheel                       |
| (2) Headlights          | (11) Hydraulic stop-slow return valve |
| (3) Side lens           | (12) Sub step                         |
| (4) Front axle bracket  | (13) Operator's seat                  |
| (5) Front wheels        | (14) Top link                         |
| (6) Steering wheel      | (15) Lower link                       |
| (7) Safety frame (ROPS) | (16) PTO shift lever                  |
| (8) Tail lamp           | (17) Flasher lamp (Side marker lamps) |
| (9) Fuel tank           | (18) Rear fender                      |

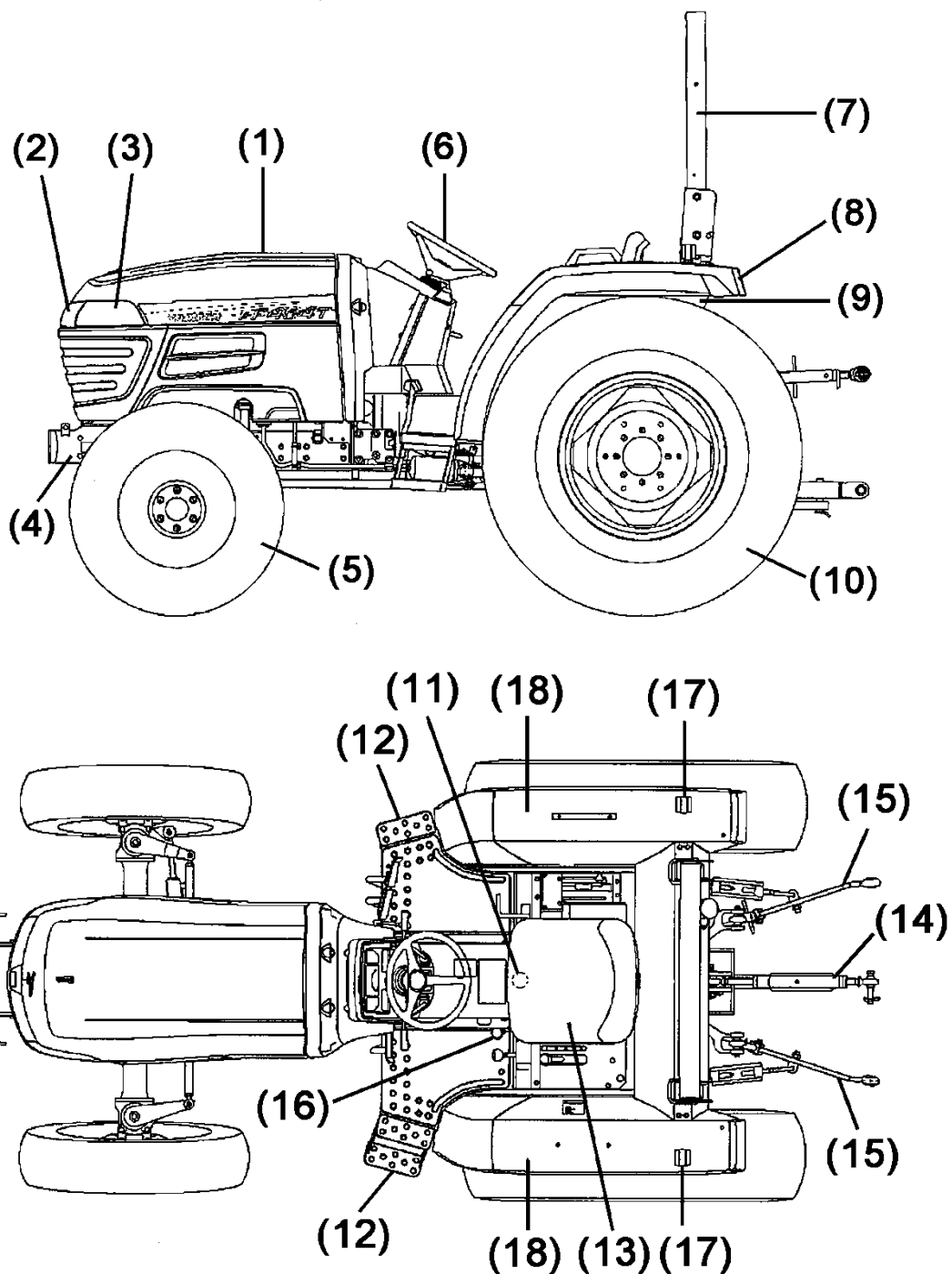



- |   |                                       |
|---|---------------------------------------|
| (1) Light switch, Horn switch, Flasher switch | (10) Accelerator lever                |
| (2) Reverser lever                            | (11) Main shift lever                 |
| (3) Clutch pedal                              | (12) Brake pedal                      |
| (4) Parking brake lever                       | (13) Accelerator pedal                |
| (5) Operator's seat adjusting pin             | (14) Differential lock pedal          |
| (6) Range shift lever                         | (15) Position control lever           |
| (7) Front wheel drive lever                   | (16) Hydraulic stop slow return valve |
| (8) Seat belt                                 | (17) PTO shift lever                  |
| (9) Main switch                               |                                       |

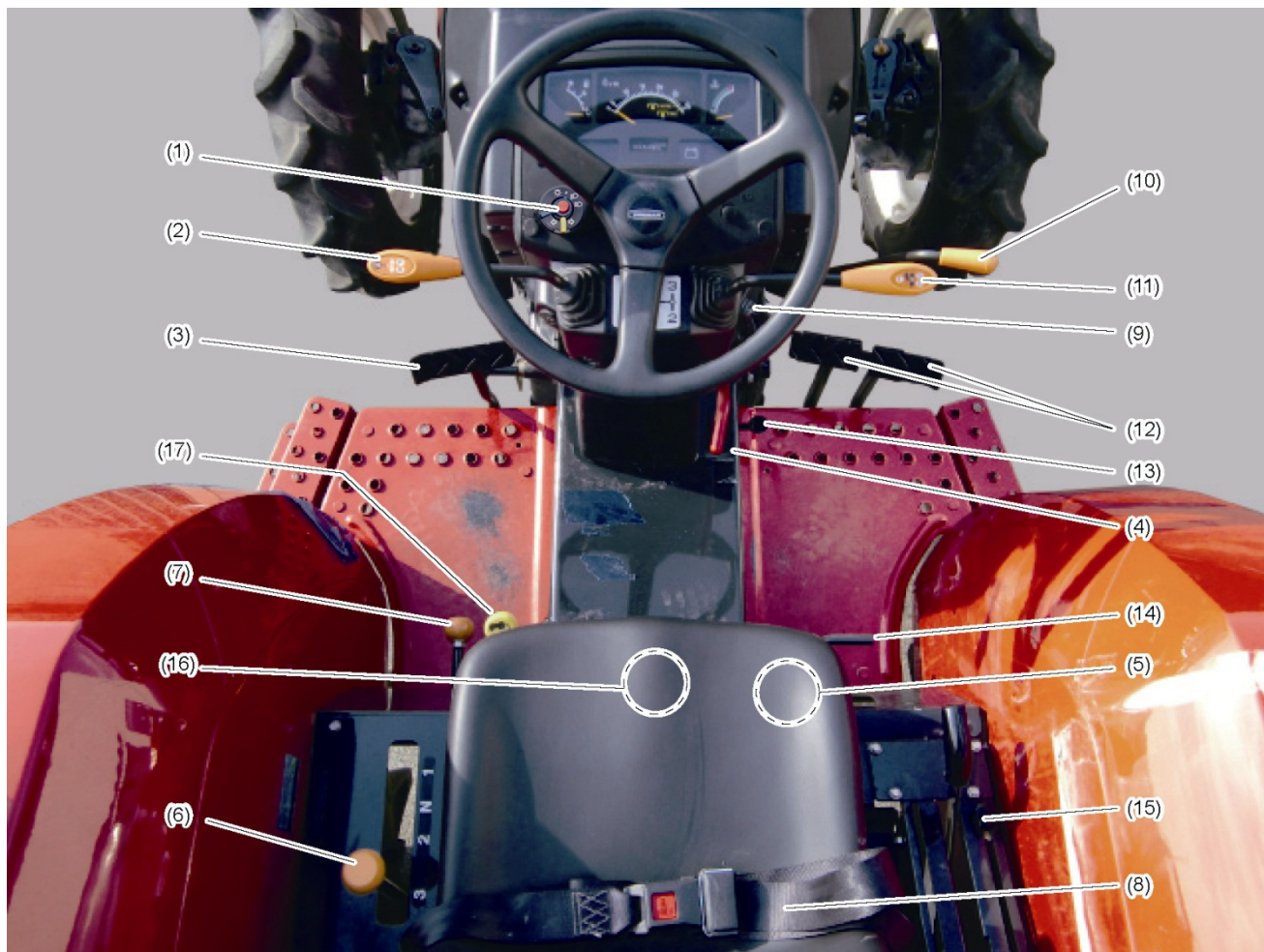

### SAFETY LABEL LOCATION

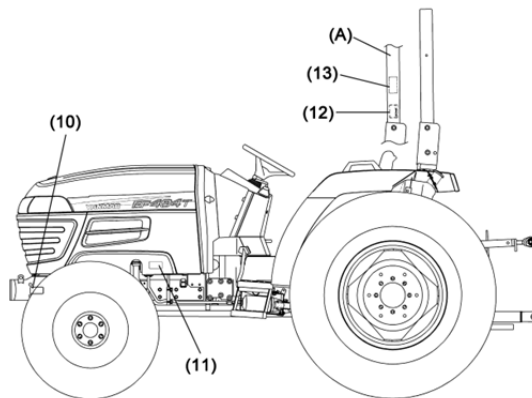
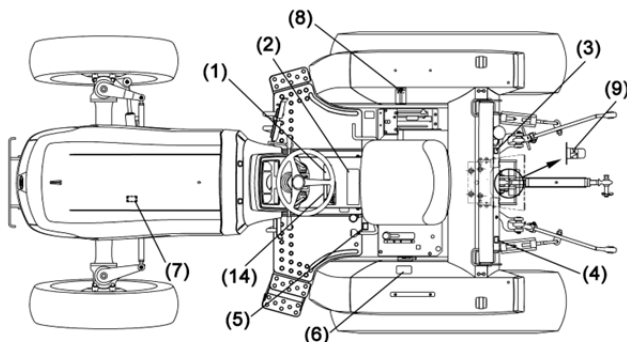

(A) ROPS right side frame

(1) 1A7874-65360  
Label, brake coupling

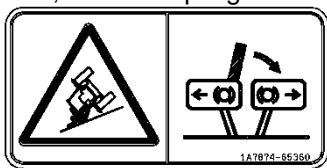

(2) 1A8310-65310  
Label, caution



(3) 1A8310-65340  
Label, fire caution



(4) 198163-65350  
Label, danger rotate shaft



(5) 198283-65651  
Label, Thailand only

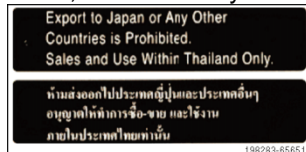

(6) Label, tractor ID

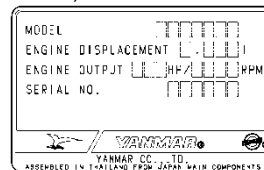

(7) Label, engine ID

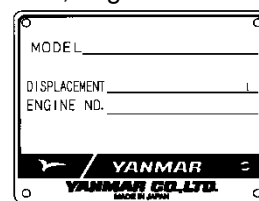

(8) 1A7781-65560  
Label, speed

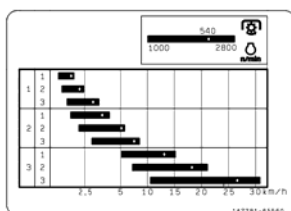

(9) 1A6150-93151  
Label, caution cover



(10) 198163-65930  
Label, caution muffler

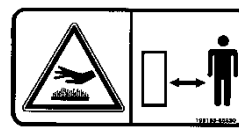

(11) 198163-65940  
Label, safety cover

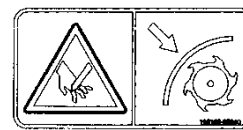

(12) Label, ROPS ID

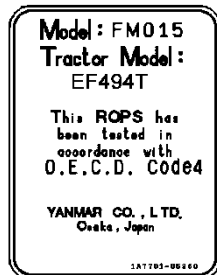

(13) 198263-65950  
Label, seat belt

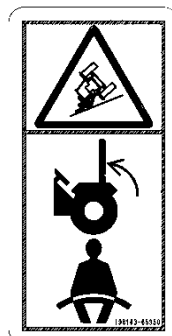

(14) 1A8310-65300  
Label, warning escape



## FUNCTION OF EACH CONTROL

### Engine

Main switch

Used to turn on and off the engine



### WARNING

When the tractor is not in use, never fail to remove the key and store it at a safe location. Do not allow a child to access the key.

- (A) START
- (B) ON
- (C) OFF

**START:** Starter motor runs to start the engine. Release the key when the engine starts, and the key returns to the "ON" position automatically.

**ON:** The electric current is on. If the engine is stopped, the engine lubricating oil lamp and charge pilot lamp turn on.

**OFF:** The electric current is shut off. The key can be removed.

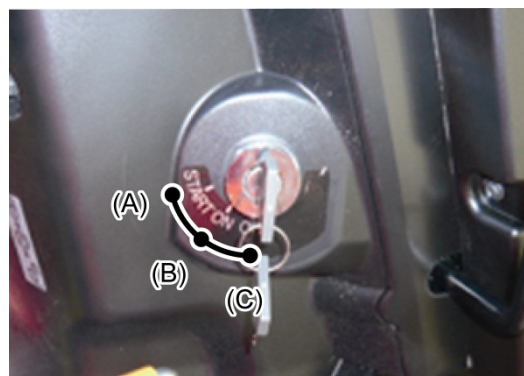

### Accelerator lever

- (A) Accelerator lever
- (B) Engine slow speed
- (C) Engine high speed

The accelerator lever is used to increase or decrease the engine speed. Used to keep the engine at a constant speed.

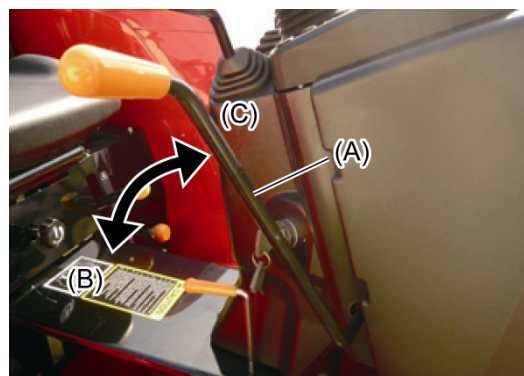

### Accelerator pedal

- (A) Accelerator pedal
- (B) Depress the pedal to increase the engine speed.
- (C) Release the pedal to decrease the engine speed.

The accelerator pedal is used to increase or decrease the engine speed, mainly during travel on the road. To increase the engine speed, depress the pedal.

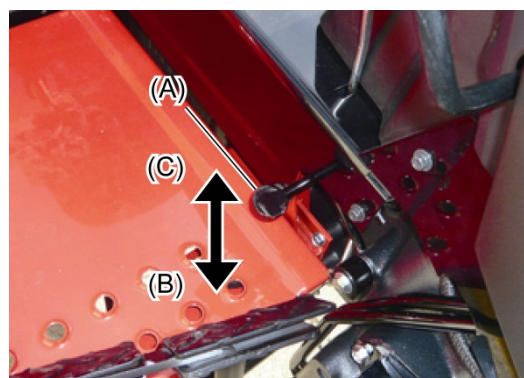

## Traveling, PTO related functions

### Main shift lever

(A) Main shift lever :1, 2, 3, N

This lever changes the transmission system in 3 stages. Combination with the range shift and reverser creates 9 forward speeds and 9 reverse speeds. Operate the main shift lever while depressing the clutch pedal.

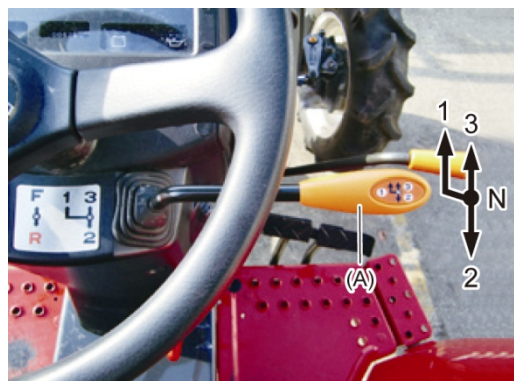

### Reverser lever

(A) Reverser lever  
(B) F: Forward  
(C) N: Neutral  
(D) R: Reverse

This lever is used to change running direction of tractor. Move the lever forward for running forward and move the lever rearward for running reverse.

Lift up the lever and move it to desired position. When shifting the lever, be sure to depress clutch pedal and that tractor stops completely.



### CAUTION

When shifting between forward and reverse, depress clutch pedal and brake pedal to stop the tractor completely and put the lever to desired direction.

### Range shift lever

(A) Range shift lever: 1, N, 2, 3

This lever changes the transmission system in 3 ranges. Combination with the main shift and reverser makes 9 forward and 9 reverse speeds.

When operating the range shift lever, be sure to depress the clutch pedal and that tractor stops completely.

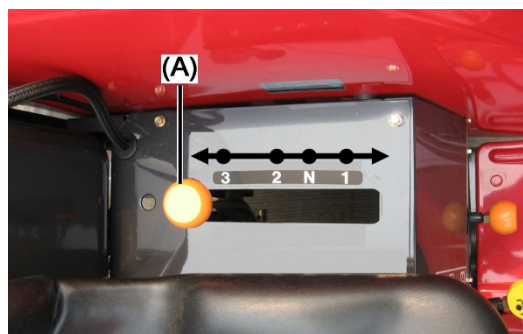

**PTO SHIFT LEVER**

**CAUTION**

Strictly maintain the PTO speed as specified by the implement. Otherwise, the implement can be damaged, leading to an accident.

(A) PTO shift lever

The PTO shaft (power takeout shaft) changes its speed in 2 stages. To change the speed, depress the clutch pedal all the way.

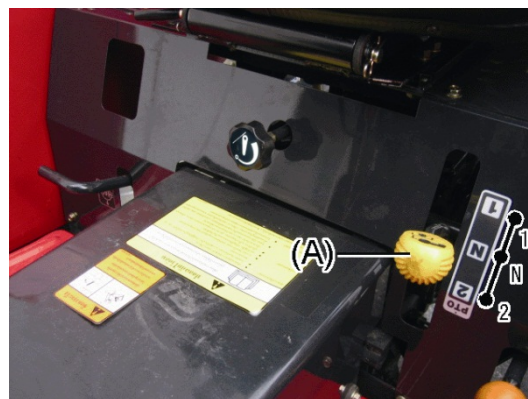

**Brake pedal**

**DANGER**

For traveling on road, link the both pedals with the connector. One sided braking can cause the tractor to make an abrupt turn or topple.

- (A) Connector link for traveling on road
- (B) Left Brake
- (C) Right Brake

Left and right pedals can be operated separately. For a sharp turn in the field, depress the brake in which direction you want to turn. The rear tire on that side will lose drive, providing a sharp turn. For traveling on road, never fail to link both pedals with the connector.

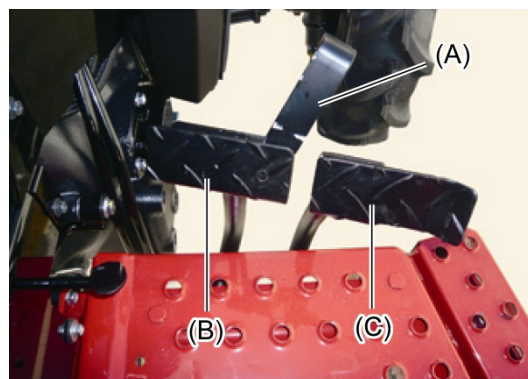

**Parking brake lever**

- (A) Parking brake lever
- (B) Brake pedal

To efficient braking, link the left and right brake pedals with the connector. Depress the pedals all the way and pull the parking brake lever upward.

To release the brake, push down the parking brake lever and depress the parking brake pedal.

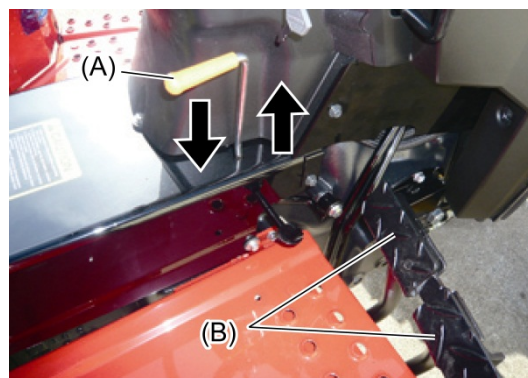

## Clutch pedal

(A) Clutch pedal

To disengage the clutch function, quickly depress the pedal. To engage, slowly release the pedal. Do not keep your foot on the clutch pedal unless necessary. Otherwise, the lifetime of the clutch may be reduced.

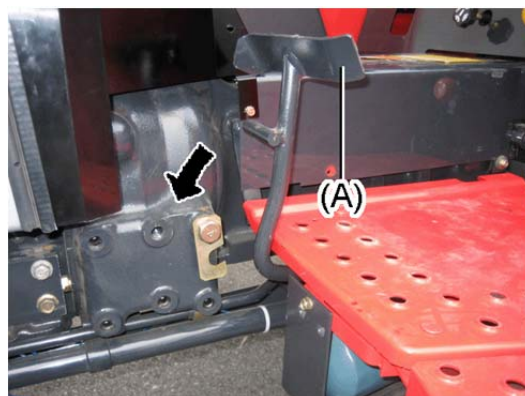

## Differential lock pedal



### WARNING

Never fail to turn off the differential lock to make a turn. Otherwise, you cannot make an intended turn and an accident may result.

- (A) Differential lock pedal
- (B) Release lock
- (C) Press to activate differential lock

This pedal makes both side wheels to turn as a consolidated form if one of rear wheels idles. This arrangement is useful to avoid slippage in muddy conditions.

Depressing the pedal automatically causes a differential lock condition. Releasing the pedal unlocks the differential system.

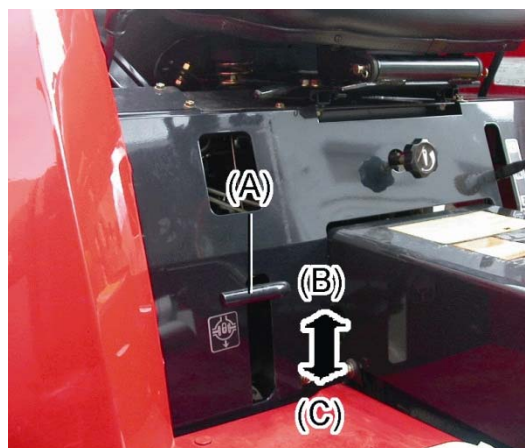

## 2WD/4WD lever

- (A) Front wheel drive lever
- (B) ON: Four-wheel drive
- (C) OFF: Two-wheel drive

This lever is used to switch between two and four-wheel drive.

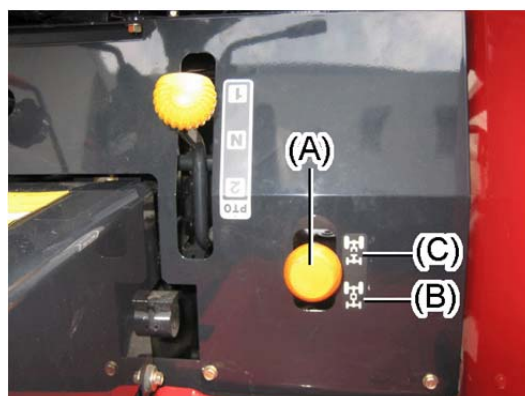

## Hydraulic system

### Position control lever

- (A) Position control lever
- (B) Raise
- (C) Lower
- (D) Stopper

This lever fixes an implement in a definite position. The stopper is used to limit the working range of the position control lever. To adjust the stopper position, loosen the knob.

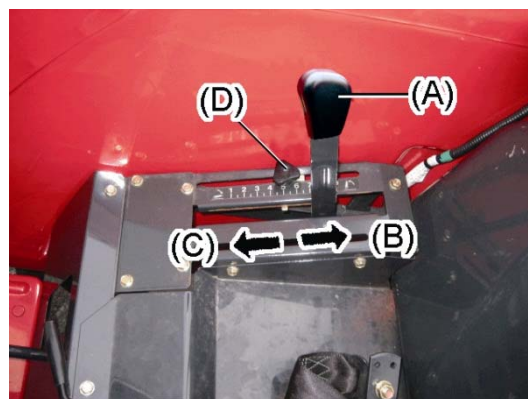

### Upper stopper stowage

Set the knob in the uppermost position.

- (A) Upper
- (B) Upper stopper
- (C) Position control lever
- (D) Knob

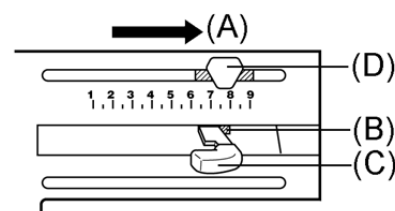

### Adjusting the stopper

Move the knob to a required position.

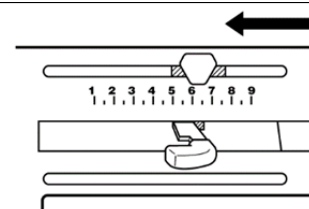

### Preventing an implement from dropping

Set the lever as illustrated.

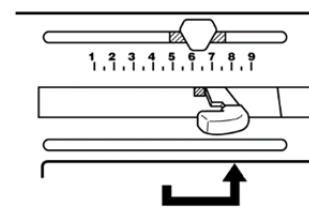

## Hydraulic stop and slow return valve

Hydraulic stop, Slow return valve

- (A) Hydraulic stop, slow return valve
- (B) Fast lowering of implement
- (C) Slow lowering of implement

Fully clockwise turn stops hydraulic pressure. Slow return function adjusts the lowering speed of an implement. Fully clockwise turn stops hydraulic pressure to the implement.

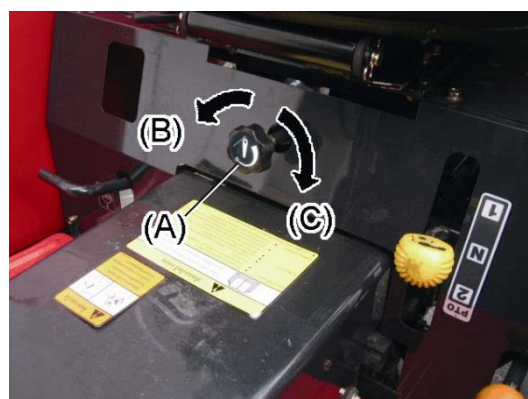

## ELECTRIC SYSTEM

### Turn signal switch

Turn signal functions when key switch turns on.

Turn the turn signal switch anticlockwise to blink right side turn signal lamp and turn clockwise to blink left side lamp.

- (A) Turn signal switch
- (R) Right lamp blinks.
- (L) Left lamp blinks.

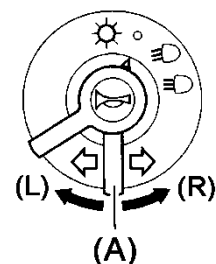

### Head light switch

Headlights turn on when key switch turns on.

Turn head light switch clockwise to turn on head lights.

- (B) Light switch
- (OFF) Headlights turn off.
- (LB) Headlights turn on with low beam.
- (HB) Headlights turn on with high beam.

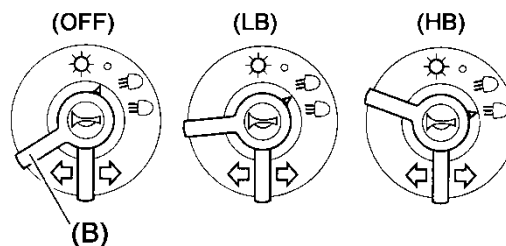

### CAUTION

When there is an oncoming vehicle in night time, be sure to switch to low beam position. If keep on high beam, it may cause traffic accident.

### Horn button

Horn functions when key switch turns on.

Push horn button to blow horn.

- (C) Horn button

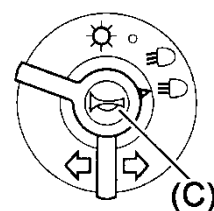



## INSTRUMENT PANEL

(A) Tachometer

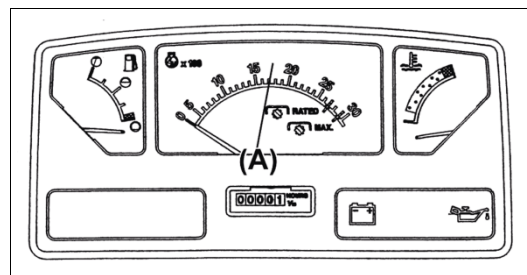

### Fuel gauge

(A) Red region

Indicates the remaining fuel level. Prepare to replenish fuel if the pointer comes in the red area.

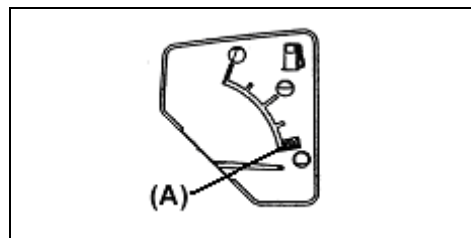

### Water temperature

(A) Red region

Indicates the temperature of the cooling water in operation. If the pointer comes in the red region, stop the work and check for abnormality.

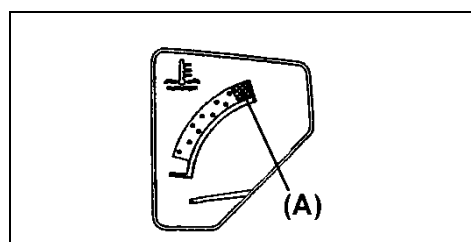

### Engine lubricating oil lamp

This lamp lights when the main switch is turned on and goes off when the engine starts. If the lamp lights during engine speed, suspect an abnormality in the lubrication circuit. Stop the engine immediately and locate the trouble.



### Charge lamp

The charge lamp goes off when the engine increases its speed above 1500 rpm and the battery starts to be charged. Note that charging will not take place at an engine speed below 1000 rpm.

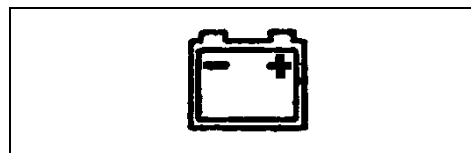

### Hour meter

Indicates the operating hour of the tractor. Multiply the figure in white frame by 6 to indicate the operating time in minutes.

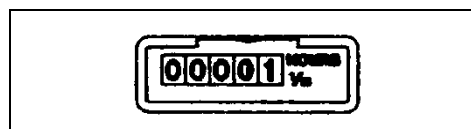

## Others

### Driver's seat adjustment pin

The driver's seat should be adjusted to suit your physical shape.

- (A) Seat adjust lever
- (B) Release
- (C) Lock

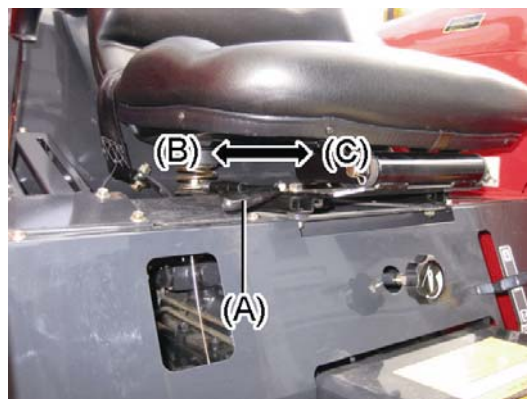

## Seat belt



### WARNING

- Always fasten seat belt while operating the tractor with the ROPS.
- Do not use the seat belt if the tractor does not have the Roll-over Protective Structure (ROPS).

- (A) Buckle
- (B) Tongue

Connect both segments of the belt with the buckle, being careful to avoid twisting of the belt, adjust the belt length, being suitable for the operator.

To unfasten, press the release button (marked **PRESS**) in the buckle.

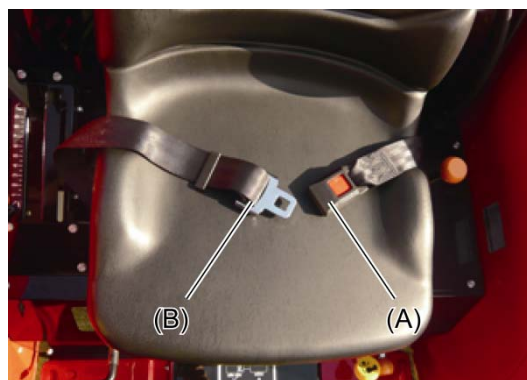

## PRE-OPERATION CHECKS

### 1. Pre-operation checks



#### **DANGER**

- Never lubricate or supply fuel oil while the engine is warm.
- Never smoke during fuel replenishing.
- Never use bare lamp/light during fuel replenishing.
- Do not crawl or step under a service machine.
- After replenishing fuel, be sure to fasten the fuel tank cap and clean off the fuel spill. A fire can result.



#### **WARNING**

- To check or service your machine, fix it on the flat ground, out of traffic of other vehicles or people. Otherwise, the tractor can collapse and cause an unexpected accident.
- When accessing beneath an implement, close the hydraulic valve completely to stop the oil flow. Otherwise the implement may abruptly fall by any reason, causing injuries to the people within the reach.



#### **CAUTION**

- Never fail to stop the engine before checks or maintenance. Otherwise, you may be trapped in the machine and seriously injured.
- To check or service the machine, wait until the engine and mufflers are cooled down. You may be burnt.
- Never fail to remount the covers and parts detached for service. Otherwise, you may be trapped in the machine and seriously injured.

For safety reasons, always check the tractor before initiating day's works. Remove any abnormalities.

### CHECK THE FOLLOWINGS IN ORDER:

(1) Abnormalities in previous day.

(2) Walk around the tractor to look into:

- Deformed parts, damages, wear.
- Air pressure of tires, wear of tires.
- Wear of various parts, loosened bolts and nuts.
- Loosened bolts and nuts of the tire rims and disks.

- Fuel oil amount and leak, damage on the fuel piping.

(3) Check inside the bonnet.

- Oil level, quality of oil, leak.

- Quantity of cooling water, damage in hoses.

- Color of the hydrometer or level of battery liquid, depending on battery type.

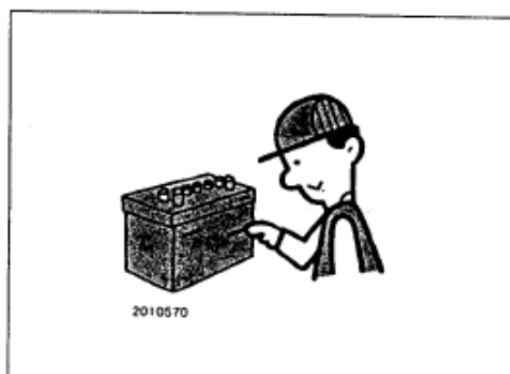
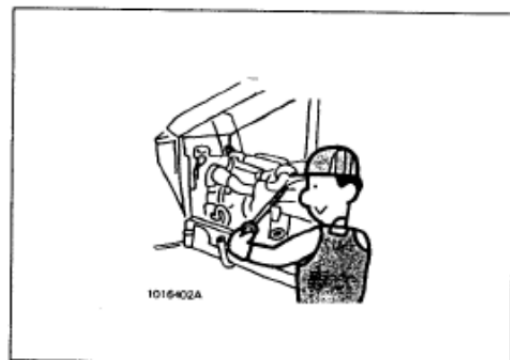
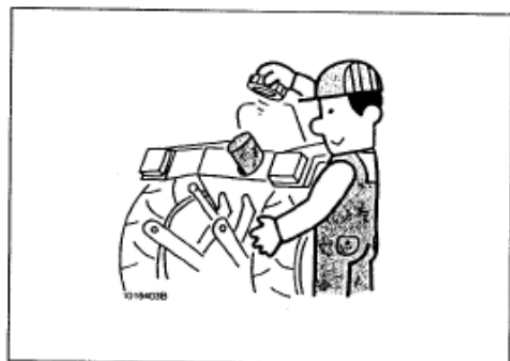

- Clogging or dirt in air filter.

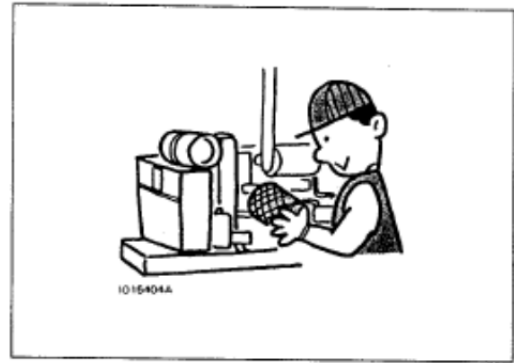

- Tension or damage of cooling fan belt.

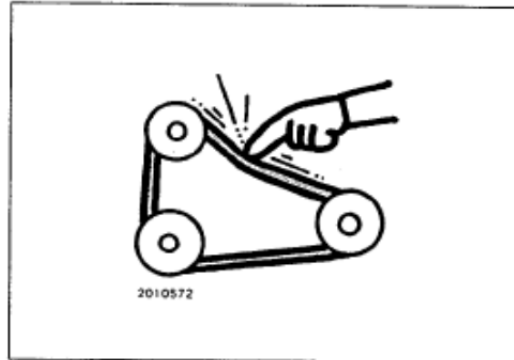

- Check the radiator grill and engine room for dust.



- Check electrical wiring for wear of sheath and loose joints.



(4) Sitting on the operator's seat.

- Effect and play in the brake.

(A) Play 30-40mm

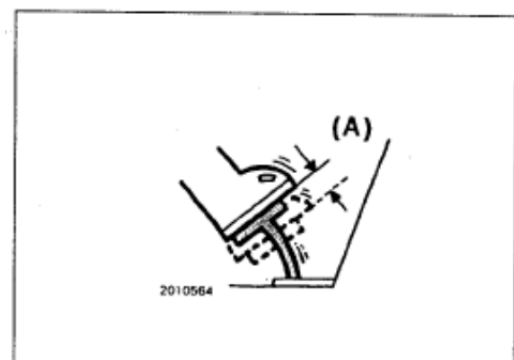

- Play in the steering wheel.

(A): Play 20-50mm

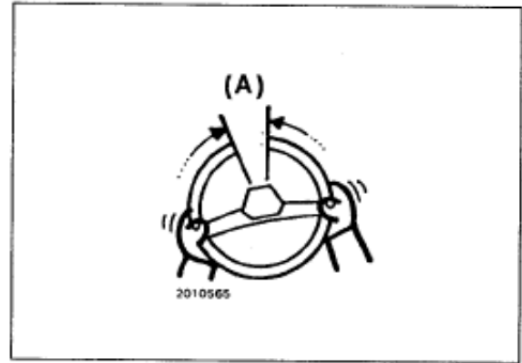

- Effect and play in the clutch pedal.

(A): Play 15-25mm

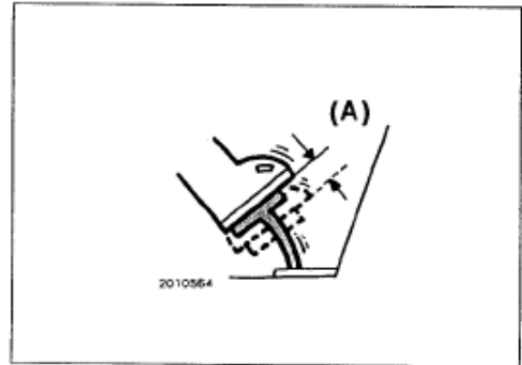

(5) Start the engine:

- Check for abnormal sound.

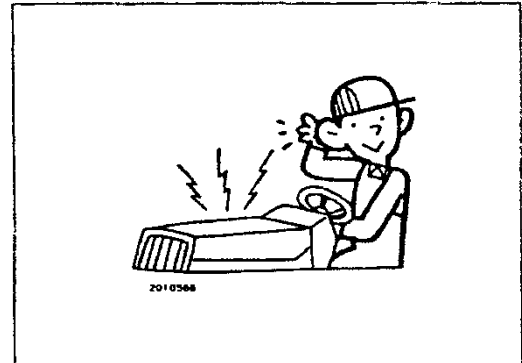

- Color of exhaust gas.

(A) What color?

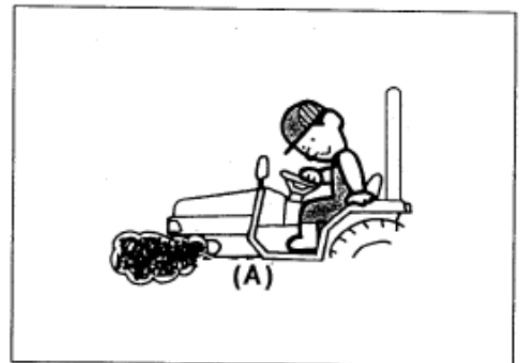

- Function of lamps and meters.

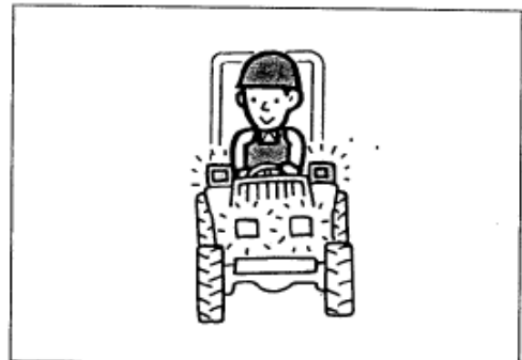

## 2. Breaking in the engine (first 50 hours)

The new tractor should be operated carefully for the first 50 hours. This will have a large positive effect on the lifetime and performance of the tractor throughout its life. Pay particular attention to the following points:

- (1) Refrain from abrupt starts and stops.
- (2) Do not use a speed higher than necessary and do not load the machine more than necessary.
- (3) Begin operation only after the engine has warmed up sufficiently.
- (4) Slow down on rough roads or slopes.
- (5) Check the tractor thoroughly after breaking it in for the first 50 hours.

## 3. Starting and stopping engine



### WARNING

- Before starting the engine, sit in the driver's seat and make sure the levers and controls are within the reach for safe operation. Negligence will cause a serious injury.
- Do not start the engine in a closed room. Start the engine outdoor where the good ventilation is available. If you are forced to start the engine in a confined room, make sure the ventilation is proper. Gas oxidation can lead to death.



### WARNING

- Before and after operation, never fail to check and service the machine. Particular check will be required at the clutch, brake pedals and controls, and steering devices. Negligence can cause a serious injury to the operator and/or damage to the machine.
- Engage the parking brake during the warm-up operation. Otherwise the tractor may abruptly start to run.

### NOTE:

In cold season, pay a special attention to the warm-up for adequate operation of the hydraulic system.

<u>Temperature</u>	<u>Warm-up operation</u>
0 ~ -10°C	more than 10 min
-10 ~ -20°C	more than 20 min
< -20°C	more than 30 min

## Starting



### CAUTION

Do not start the engine if the position control lever is not in the LOW position. The implement may abruptly raise causing a damage or injury to the human and machine.

- (1) Set the fuel filter and water separator to "O" to open the fuel cock.

(A) Fuel cock open

(B) Fuel cock close

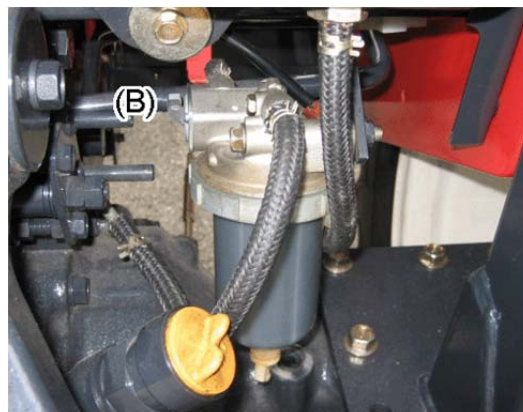
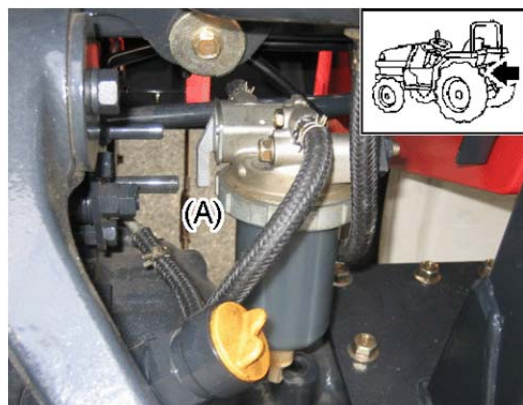

- (2) Put the main and range shift levers, reverse lever and PTO shift lever in the N position.
- (3) Set the position control lever in LOW.

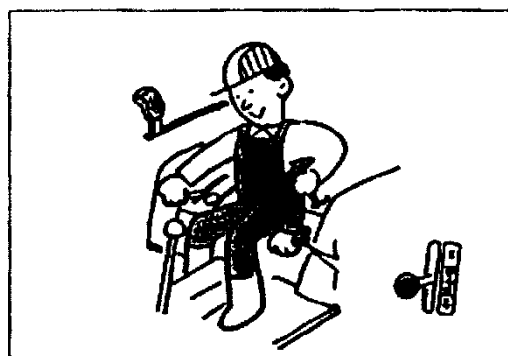

- (4) Put the accelerator lever in the TOP position. Fully depress the clutch pedal and turn the main switch to START.
- (5) After the engine has started, immediately release the main switch.



### IMPORTANT

\* The engine cannot be started without putting both the main and PTO shift levers in the N position.

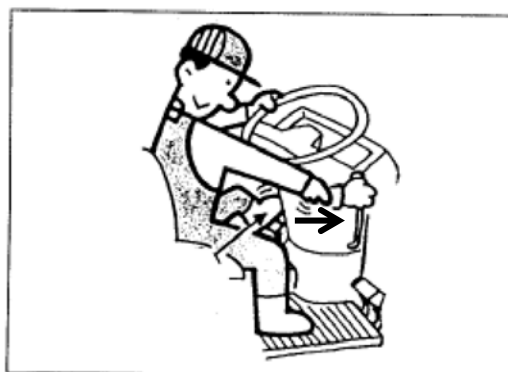



(6) Warm up the engine by running under no-load at 1500 rpm for 5 minutes approximately.

(A) 1500 rpm

**NOTE:**

- The starter motor consumes plenty of current from the battery. Do not keep it running for more than 10 seconds. If it fails to start the engine, allow one minute before retry. Then, execute steps (6) - (7).
- Never turn the main switch to START if the engine has been started or is running.

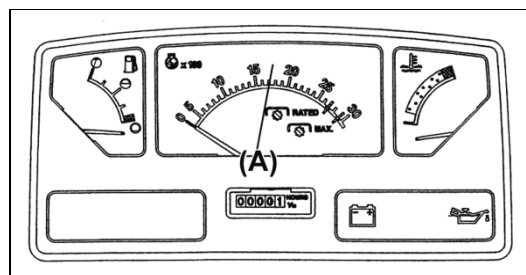

**Stopping**

- (1) Reduce engine R.P.M. with the accelerator lever.
- (2) Turn the main switch to OFF.



**IMPORTANT**

Stopping a hot engine suddenly can damage the engine because of overheating. Keep engine running unloaded at 1200 - 1500 RPM for about 2 minutes, to prevent damage.



**4. Raising or lowering implement**

Adjust the position control lever back and forth to raise or lower the implement.

- (A) Position control lever
- (B) Lower
- (C) Raise

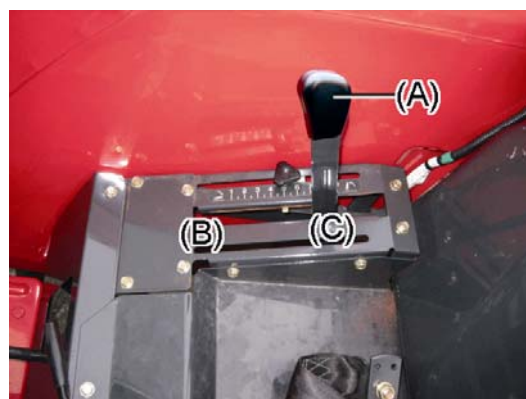

**5. Adjusting lowering speed for implement**



**WARNING**

Never crawl beneath or step in the implement. Severe injury may result.

To reduce the lowering speed for an implement, turn the hydraulic stop slow return valve clockwise. To increase the speed, turn the valve counterclockwise. Turning the valve fully clockwise will stop the oil pressure and stop lowering the implement no more.

- (A) Fast descending speed
- (B) Slow descending speed

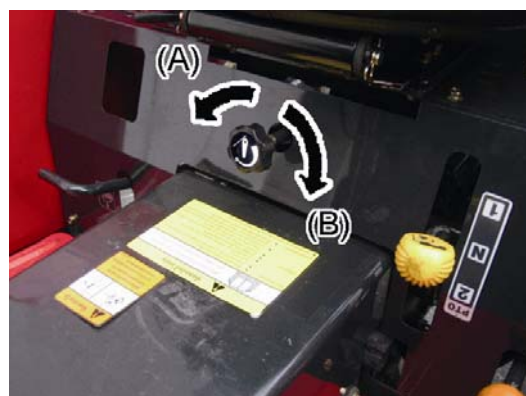

**NOTE:**

Do not operate the position control lever when the hydraulic slow return valve is closed. Hydraulic parts may be damaged.

## 6. Starting and stopping



### WARNING

- Make a slow start after calling attention of the people in the vicinity. Do not make an abrupt start. Human injury can result.
- For traveling, never fail to link the left and right brake pedals with the connector.
- When you leave the tractor, park it on the safe flat location; never fail to put on the parking brake, put the reverse lever and range shift lever in N (neutral); and lay down the implement on the ground. Block the wheels. Otherwise, the tractor may move without intention of the operator, causing a serious accident.



### CAUTION

Never keep your foot on the clutch pedal while traveling or working. Otherwise, an accident may result.

### NOTE:

Operate the main shift lever and the range shift lever or reverse lever after the machine stops completely.

### Starting

- (1) Check that the left and right brake pedals are tied together with the connector.
- (2) Set the engine speed around 1500 rpm with the accelerator lever.
- (3) Move the position control lever to Upward to lift the implement to a maximum height.
- (4) Depress the clutch pedal and place the main and range shift levers in the wanted position.
- (5) Put the reverse lever in the position of F or R.
- (6) Slowly release the clutch pedal. The tractor starts to run.

### Stopping and parking

- (1) Return the accelerator lever to LOW to slow down the speed.
- (2) Depress the clutch and brake pedals to stop the tractor, and set the main shift lever in position N.
- (3) Put the main shift lever, reverse lever and PTO shift lever in N (neutral).
- (4) Make sure the left and right brake pedals are connected with the connector. Depress the brake pedal and put on the parking brake.
- (5) Lay down the implement, if any, on the ground by putting the position control lever in LOW.
  - (A) Position control lever
- (6) Turn the main switch to OFF to stop the engine.



## 7. Traveling on the load

### WARNING

- To travel on the road or cross a farm ridge, never fail to link the left and right brake pedals. One-sided braking effect will roll over the tractor or result in a sharp turn.
- Follow the traffic regulations and rules when running on the road. Wear the helmet.
- Do not carry other persons except a driver.

### CAUTION

- Remove implements are better when traveling on the road, or an accident may result.
- Put the PTO shift lever in N and link the right and left pedals together.
- For traveling on the road or to lock the hydraulic device in the upper position, adjust the upper stopper and move the position control lever to the stopper.

(A) Position control lever

(B) Upper stopper

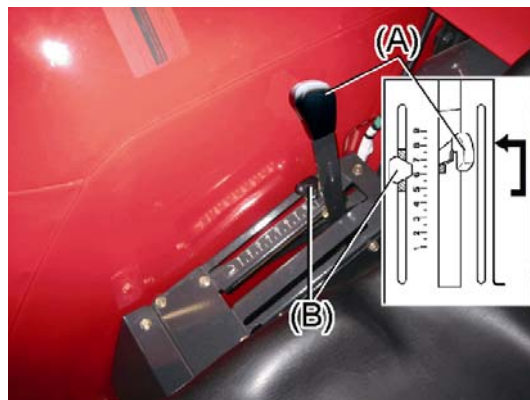

- Adjust the traveling speed with the foot accelerator pedal.
- To change the traveling course, notify others by flasher switch.
- Watch any following cars on the rear view mirror and give way to them.
- On narrow farm paths, tilled ground or roads with weedy shoulders, travel at a reduced speed noting the road shoulders.
- When passing other cars at night, switch the headlight to the low beam for the convenience of others to pass by.

(A) Low beam

(B) Flasher switch

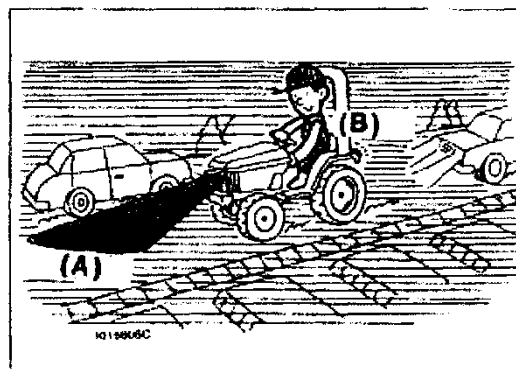

### NOTE:

When traveling, keep open the hydraulic stop slow return valve and put the position control lever in the RAISE position, and the set the stopper.

## 8. Traveling on the slope



### WARNING

- Do not change speeds on the slope. Travel slowly on the slope. Use the engine brake on down-slope.
- Do not travel on the slope with the reverser lever, the main shift lever or the range shift lever set in the N position.
- Do not depress the clutch on the slope; it causes a great danger as the tractor may glide down.
- To start on an up-slope, use a low gearshift and set off at low speed. Abrupt start will jump up the front wheel.
- Before leaving the tractor, stop the engine, set the parking brake and block the wheels.
- Shift should be changed after reaching a highest point on the slope. To stop on the slope, lock the parking brake lever.

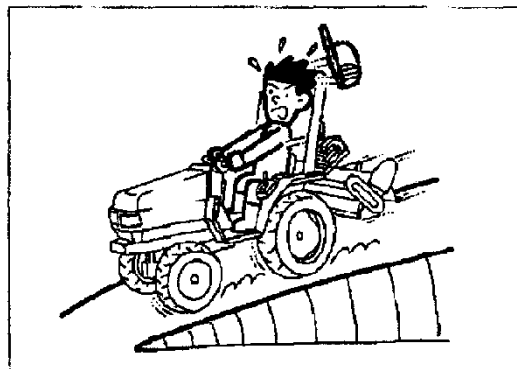

## 9. Power steering



### CAUTION

The steering wheel is easily rotated when the tractor is running.

Pay a special attention in operating the steering wheel when traveling on the road. Power steering is effective only while the engine is running. The steering wheel will be slightly heavier at a low engine speed.



### IMPORTANT

- Turning hard the steering wheel will cause the relief valve to sound a blowing sound. Do not operate the tractor with this sound continuously for an extended period. It damages the hydraulic components.
- Do not operate the steering wheel while the tractor is stationary except for an unavoidable case. Otherwise the tires or rims are damaged.

### 10. Driving in and out of Fields

**! WARNING**

- Always connect the left and right brake pedals with the connector. Otherwise, one-sided braking can cause a roll over.
- When approaching the field or when crossing a ditch, use a gangplank of sufficient strength to enter the field. Lower any implement to reduce the center of gravity.
- Climb a slope backwards, in reverse. Drive down a slope forward, in low gear.
- Before starting to climb a hill, lower any implement. After the rear wheels are on the ridge (A), you can lift the implement.

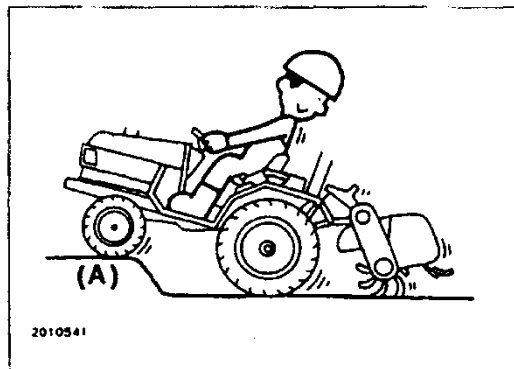

(A) Ridge

### 11. Setting an adequate speed

9 forward speeds and 9 reverse speeds are available by the combination of main, range and reverse shift levers. Use an adequate speed for works referring to the table below.

- (A) Main shift lever
- (B) Range shift lever
- (C) Reverse shift lever

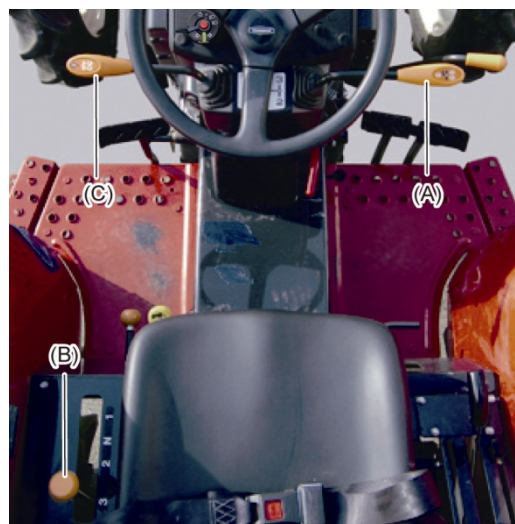

### Driving Speed

F/R	Shift position	Main shift	Range shift	km/h
<b>Forward</b>	1	1	1	1.63
	2	2	1	2.26
	3	3	1	3.30
	4	1	2	4.00
	5	2	2	5.57
	6	3	2	8.14
	7	1	3	14.18
	8	2	3	19.72
	9	3	3	28.80
<b>Reverse</b>	1	1	1	1.68
	2	2	1	2.33
	3	3	1	3.41
	4	1	2	4.13
	5	2	2	5.74
	6	3	2	8.39
	7	1	3	14.62
	8	2	3	20.33
	9	3	3	29.70

## 12. Turning in a field



### WARNING

Disconnect the differential lock before turning. Otherwise, an intended turn will not be possible and an accident may result. Refer to the relevant section for operating the differential lock.

Reduce the engine speed and make a slow and smooth turn. To enable a quick turn in the field, remove the connector linking the left and right brake pedals; upon turning the steering wheel, depress the brake pedal in the direction to which you want to turn. Lift up the implement and turn.



## 13. Position control

The position control maintains an implement in a wanted height.

- (1) Set the implement in an adequate height with the position control lever.
  - (A) Position control lever
  - (B) Stopper
- (2) To set the lower limit of the implement, adjust the position control lever until it stops in a wanted position. Fix it with the lowest stopper.

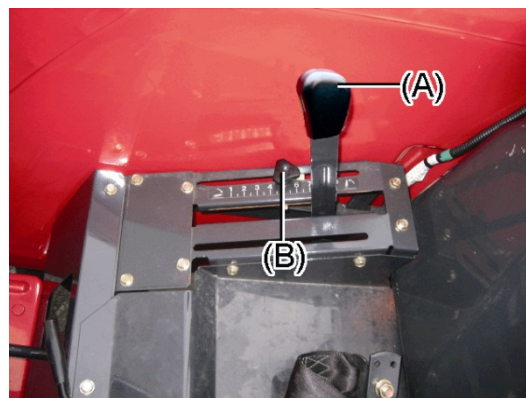

## 14. Using differential lock



### WARNING

- Disengage the differential lock before making a turn. Otherwise, intended turn is not possible and an accident will result.
- Do not use differential lock while traveling on the road. Otherwise, stable drive is not assured, incurring an accident.

Depressing the differential lock pedal locks the differential gearing and causes both side wheels to turn at the same speed. Releasing your foot from the pedal will automatically bring back the differential system. Lock the differential system when running or leaving a muddy path. It is also useful when the tractor fails to travel along a linear course.

(A) Differential lock pedal



### IMPORTANT

- Set the differential lock after reducing the engine speed.
- If difficult to unlock the differential system, try to depress the clutch pedal or lightly depress the brake pedal.



## 15. Loading and unloading



### DANGER

While loading or unloading tractor to or from the truck, never try to change the course on the gangplank. Use the slowest speed. Do not use the clutch. Otherwise, loss of control can result in injury or damage to the tractor.



### WARNING

- Park the truck on the flat ground where less traffic is expected. Stop the engine and lock the parking brake. Block the wheels of the truck. Use the gangplank of sufficient strength. Fix or tie the gangplank on the truck.
  - Reverse shift for loading, forward shift for unloading
  - Fasten the tractor firmly with the rope. If the tractor falls off the truck, it may be damaged or injure someone.
- (1) Prepare the gangplank of sufficient strength.
  - (2) Never fail to link the two brake pedals with the connector.
  - (3) Put the shift in the LOW position and load the tractor onto the truck with a reverse shift.
  - (4) Should engine failure occur, descend down the gangplank. Restart the engine and climb the gangplank.

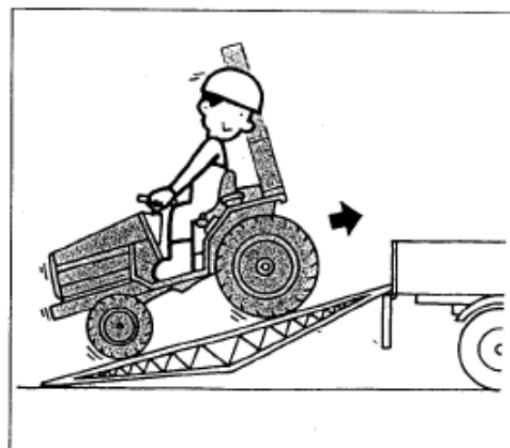

## 16. Adjusting wheel tread

Adjust the tractor wheel tread according to the type of crops and widths of planting rows.

Apply a wide wheel tread for works on slopes or for a traction work.

Consult your service outlet for the adjustment of the wheel tread.

**!** **DANGER**

- Do not drive the tractor if the wheel mounting bolts or nuts are loose. If the tractor is driven with loose nuts or bolts, there is a possibility that an accident will occur.
- Make daily and periodic wheel inspections to check for loose nuts and bolts on the wheels. If they are loose, retighten them to the specified torque.
- When wheel tread width was changed, check the bolts and nut tightening after the first 10 hours and again after the 50 hours. If the bolts are loose, retighten them. After that, check every 100 hours operation.

**Fastening torque (Front and rear)**

Fixing bolts for wheel and axle shaft:  
186 N-m (19 kgf-m)

**FRONT TIRE: 8-18**

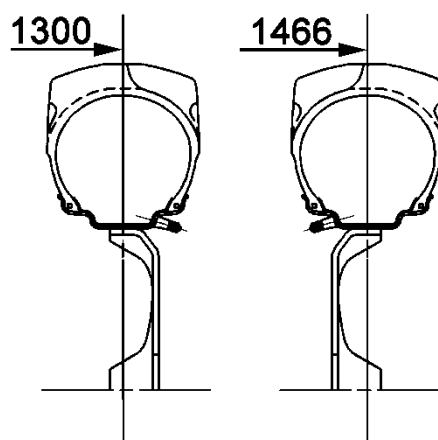

**REAR TIRE: 13.6-26**

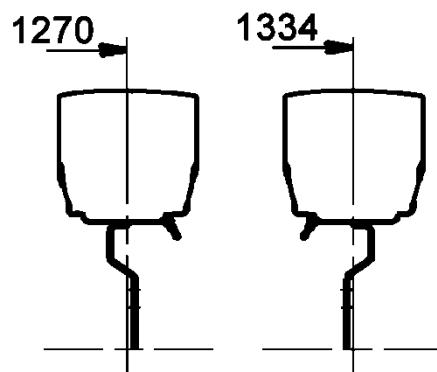



## 17. Hydraulic output



### CAUTION

Never fail to stop the engine before trying to detach the hydraulic plug or pipes. Otherwise, you may be injured by high pressure oil.

### Single action cylinder (e.g. dump trailer)

- (1) Set the position control lever about 20 mm below the top position.

(A) Position control lever

(B) About 20 mm

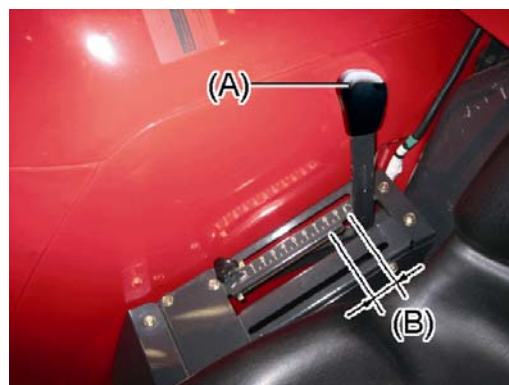

- (2) Fasten the hydraulic stop slow-return valve fully clockwise.

(A) Hydraulic stop slow-return valve

(B) Close

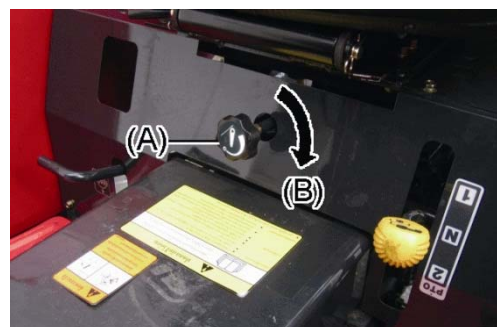

- (3) Remove the hydraulic output plug, and connect the high pressure hose of an implement.

\* Keep removed copper packing and plugs.

(A) Hydraulic output plug

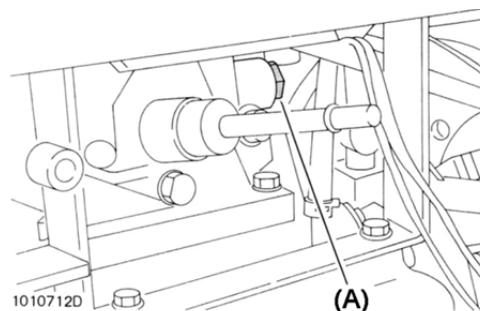

### NOTE:

3-point rear hitch implement cannot be controlled by position control lever while stop slow-return valve is closed.

### Double action cylinder

- (1) Remove the plug (A). Insert and tighten the screw plug (B) to switch inner hydraulic oil flow.
- (2) Remove plugs (D) on the right side of hydraulic housing. Put the filter adapter (C) to the return port (IN). Connect the hydraulic valve of implement.

Port at the front side: OUT (to take out)

Port at the rear side: IN (to return)

(A) Plug, 3/4-16UNF

(B) Screw plug, PTF 1/4-18 (198245-42160)

(C-1) Filter adapter, 3/4-16UNF (1A7780-45950)

(C-2) Gasket, 19x1.0 (23414-190000)

(D) Plug, 3/4-16UNF

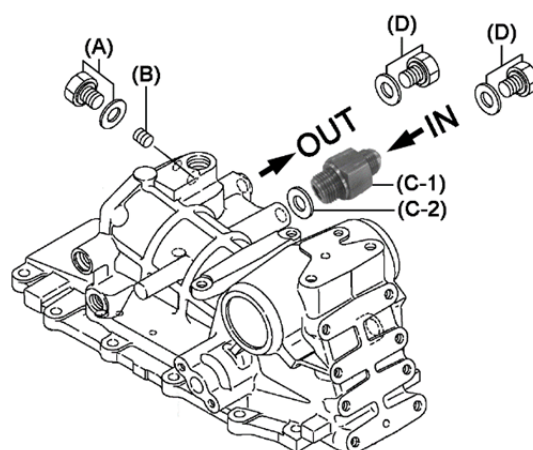

### NOTE:

Rear hitch implement can be controlled by position control lever.

Keep plug (D) for future reuse.

### 18. Using 3-point link

(1) Mount the lower link on the lower link hinge and fix it with a lock pin.  
 Left and right links are commonly usable, but note the front and rear position. Mount the link so that the link mounting hole comes backward.

- (A) Lower link
- (B) Lift link mounting holes

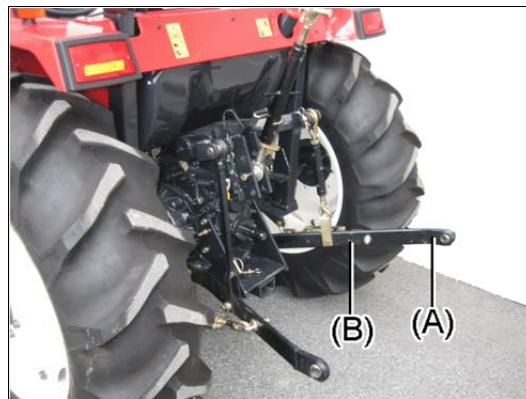

(2) Fix the check chain on the chain bracket and the lower link mounting holes (rear-most). Foremost holes are used for coupling the lift link.

- (A) Check chain bracket
- (B) Check chain

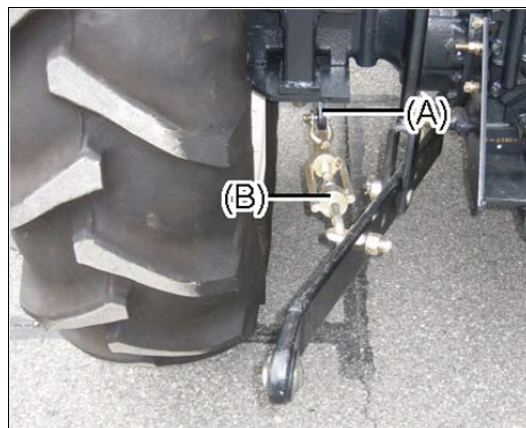

(3) Couple the lift link with the lift arm and the lower link.

- (A) Lift link
- (B) Lower link

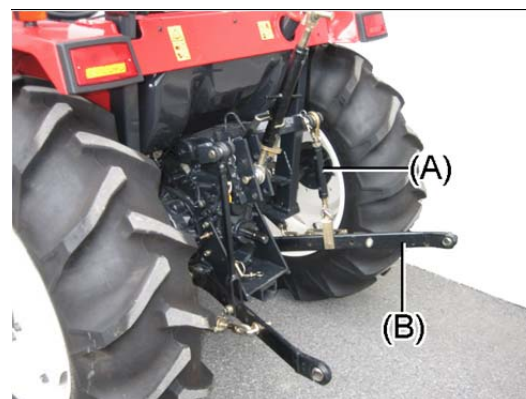

- (A) Lift link hole
- (B) Lower link hole: Not possible to use
- (C) Lower link hole: Standard
- (D) Lower link hole
- (E) Check chain
- (F) Lower link separation

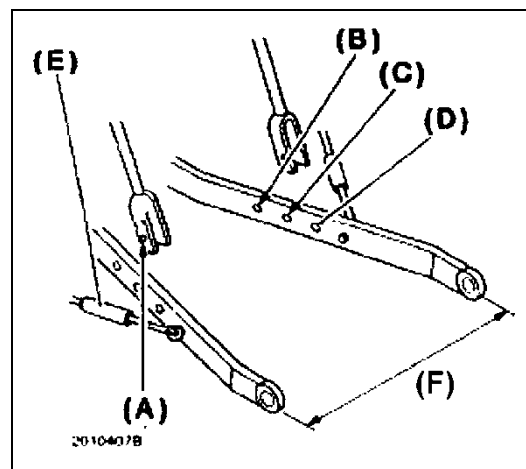

\*Identify the left and right lift links. Mount the adjustable one to the right and the fixed one to the left.

- (A) Left lift link (Fixed)
- (B) Right lift link (Adjustable)



- (4) Install the top link at the top link hinge hole.  
Chose (A) or (B) or (C) depending on the implement.

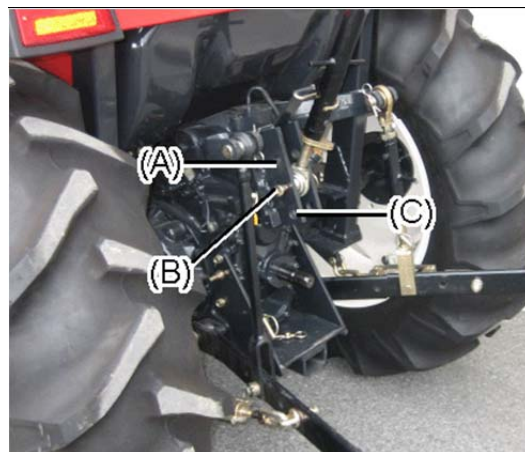

## 19. Adjusting top link

Loosen the lock nut for the top link and turn the turnbuckle to adjust the length of the top link. When an implement is not used, hang the top link on the hook.

- (A) Hook
- (B) Lock nut
- (C) Top link



### IMPORTANT

Install the top link lock nut (B) on the implement side. If the lock nut were to be mistakenly installed on the opposite side, it will cause the top link to be damaged.

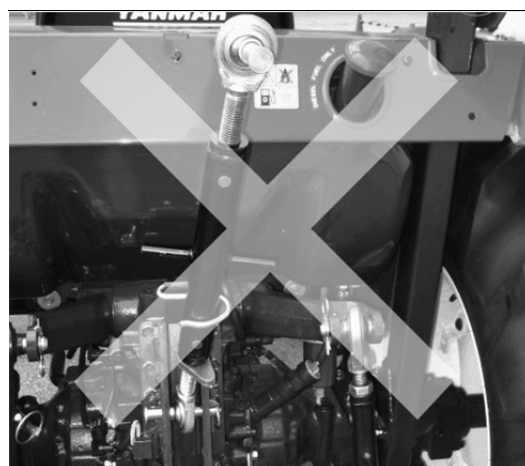
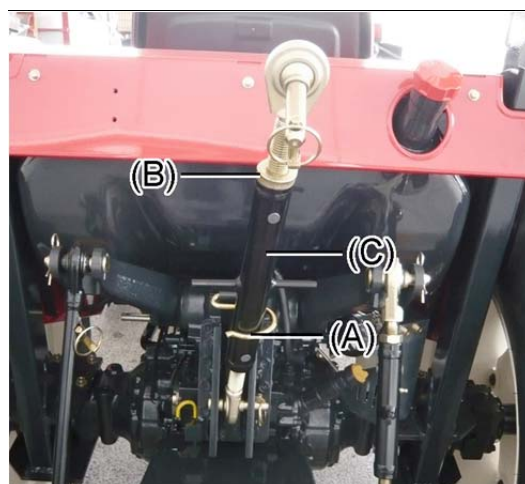

## 20. Mounting general farm implements

(1) Adjust the length of the right lift link to make the left and right lower links equal in height.

- (A) Lower link
- (B) Lift link

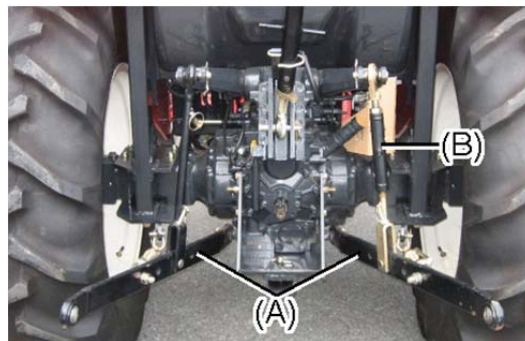

- (2) Align the center of the tractor with the center of the implement on the flat ground.
- (3) Fix the left lower link on the implement, then fix the right lower link. If the right lower link pinhole is out of position, turn the lift link to bring the hole in the position.
- (4) Fix the standard top link on the top link hinge using the ball socket lock pin. Next, loosen the top link lock nut and turn the turnbuckle. Lock the implement with the lock pin.
- (5) Loosen the lock nut of the top link and turn the turnbuckle for adjustment. Fix the implement in the top link mounting position with a pin.

- (A) Top link
- (B) Top link hinge
- (C) Right lift link

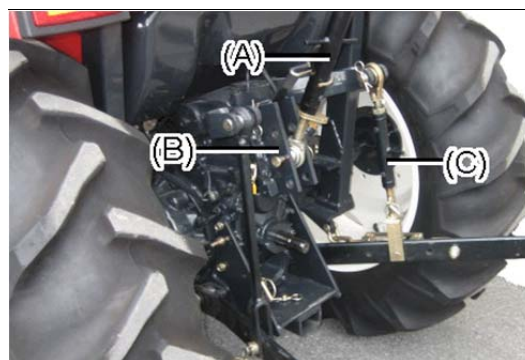

- (6) Lower the implement on the ground. Adjust its posture with the top link turnbuckle.
- (7) To install an implement requiring the drive force, follow the instruction on the nameplate mounted on the safety cover for the drive shaft.
- (8) Lift the implement slightly and make sure it is level. If not, adjust the right lift link.
- (9) Lift the implement to a maximum height and rotate it with a hand. If it is hard to rotate with a hand or if the rotation is not smooth, adjust the length of the top link.

## (10) Check chains

Adjust check chains (A).

- 1) For use of implements such as a plough, harrow and subsoil, adjust check chains (A) so that an implement can move 5 - 6 cm to right and left. Prevent an implement from swinging to hit against the wheels and tires.
- 2) For use of implements such as a rotary tiller and mower, adjust check chains (A) so that an implement can move 1cm to right and left.

(11) Dismantling is done in the reverse order as the fixing process.



### IMPORTANT

- Remove the drawbar if the drawbar interferes with an implement.
- Fasten lower links to prevent from swinging to hit against wheels and tires when driving the tractor without an implement.

## 21. Notes on using service implement



### WARNING

- When moving the tractor to mount an implement, never allow a person or persons between the tractor and the implement.
- Mount or dismantle an implement on a flat ground using a safe method. Use the lighting during nighttime works.
- When a heavy implement is mounted on the tractor, apply a counterbalance to maintain a balanced condition.
- Before leaving the tractor for mounting an implement, never fail to engage the parking brake and stop the engine. Make sure the PTO shift lever is in N.
- For traction work, always use the draw bar. Do not attach to other parts of the tractor.
- Use a wider wheel span for a traction work or works on the slope.
- Do not operate the low speed machines at a higher speed than the rated. Maintain the rated PTO speed.
- When drawing a trailer, interlock the trailer brake with the tractor brake. Do not change the shift on the slope.
- Mounting an implement machine results in a considerable overall length; be careful not to hit farmers or constructions in the vicinity.

**Negligence of safety precautions may cause serious injury or death.**



### WARNING

Running the PTO speed below or above the rated operating speed of the implement may cause damage to the tractor or the implement.

## 22. Using PTO shift lever



### CAUTION

USE the specified PTO Speed. **If not**, the implement can be damaged and cause an injury to people in vicinity.

PTO speed can be changed in **2 stages** to suit a particular work. To change the shift, completely disengage the PTO clutch by stepping on the PTO clutch pedal. When the PTO is not used such as while running on the road, set the PTO shift lever at N position.

(A) PTO shift lever

PTO speed

**PTO shift** PTO speed (rpm)

1 568

2 769

(Engine speed is : 2800rpm)

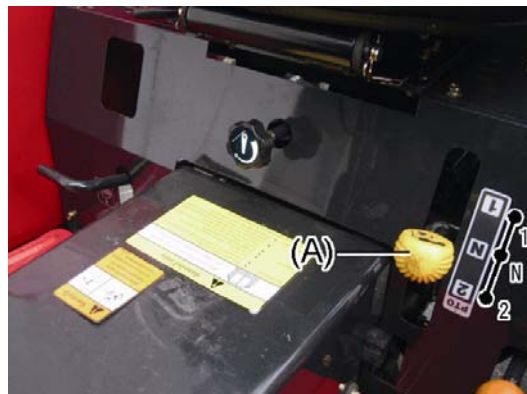

## 23. Using drawbar hitch



### DANGER

Traction should always be done with the drawbar hitch. Traction at the top link or rear axle causes the tractor to roll over.

A stationary drawbar hitch is provided.

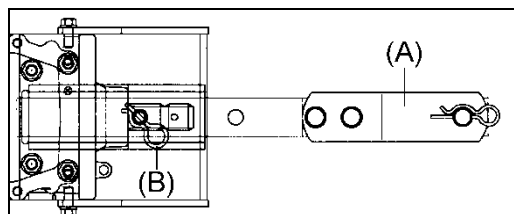

(A) Draw bar hitch

(B) Fixing pin

### Combined PTO drive and traction

For a combined operation of PTO drive and traction, the length from the edge of the PTO shaft to the mounting position on the drawbar hitch implement is set to 356 mm.



### CAUTION

Avoid injury!

- Use only the drawbar that was provided with the machine. Do not install or use a floating-type drawbar or any other type drawbar.
- If a longer drawbar hitch were installed, there is a possibility that the attached section might be damaged and the implement could become disconnected.
- Hitch towed loads only to the drawbar to avoid rearward upset.



### IMPORTANT

Avoid damage!

- Maximum static vertical load on drawbar should not exceed the maximum recommendations. Drive slowly with heavy loads.
- Strain is greatly increased by speed and rough ground. Do not exceed maximum vertical load 374kg on drawbar.

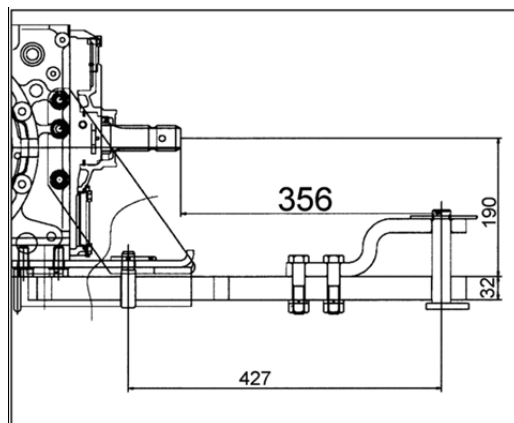

## 24. Safety frame (ROPS)

The safety frame is designed to protect the driver from an accident. Never fail to use the safety frame when the tractor is in use.



### WARNING

- Always fasten the seat belt while operating the tractor with Roll-over Protective Structure up.
- Do not use the seat belt if the foldable Roll-Over Protective Structure (ROPS) is in the folded position or the tractor does not have the ROPS.
- Do not modify the safety frame. Safety factor can be lost.
- Damaged frame should be replaced as a complete set. Partial repair may lead loss of safety level.

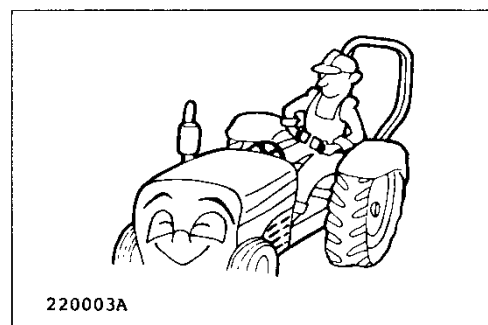

220003A

### Folding in safety frame

- (1) Loosen bolts (B) and remove bolts (A).
- (2) Push down the frame backward.
- (3) Install bolts (A) as the right figure shows and tighten all bolts (A), (B).

(A) Bolt M16x100 2 pieces

(B) Bolt M16x100 2 pieces

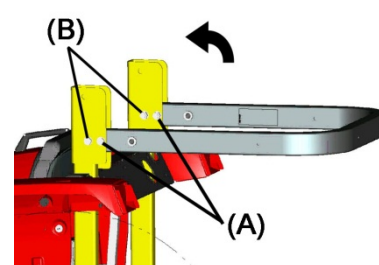
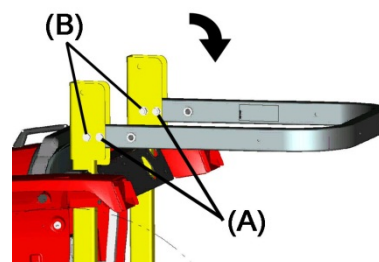
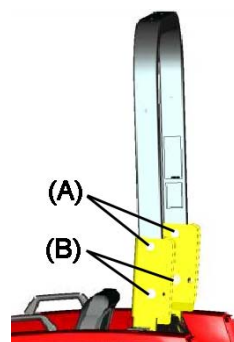

### Setting up the safety frame

- (1) Loosen bolts (B) and remove bolts (A)
- (2) Push up the frame.
- (3) Install bolts (A) as the right upper figure shows and tighten all bolts (A) and (B).

#### Bolt tightening torque:

167-206 N-m (17-21 kgf-m)

(A) 26156-161002 Bolt M16x100, plated 2 pcs.

(B) 26156-161002 Bolt M16x100, plated 2 pcs.

(C) 26356-160002 U-nut, M16 4 pcs.

(D) 22137-160000 Washer 16, polished 8 pcs.

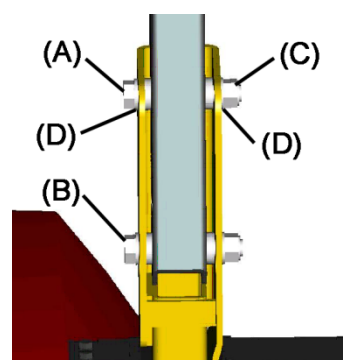

## AFTER OPERATION

### 1. After operation



#### DANGER

To cover the tractor for storage, allow at least 10 minutes of cooling time after the engine has been stopped. Otherwise, a fire may start.

Wash the tractor with water, wipe off, and lubricate the moving parts and sliding parts. Fill grease to the grease nipples.



#### CAUTION

- Never fail to stop the engine before stating checks and maintenance. You may be pulled into the machine and be injured.
- Wait until the muffler and the engine get cool before starting checks and maintenance.

#### NOTE:

Be careful not to spray water on electrical parts. Water infiltration can cause a trouble in the electrical system.

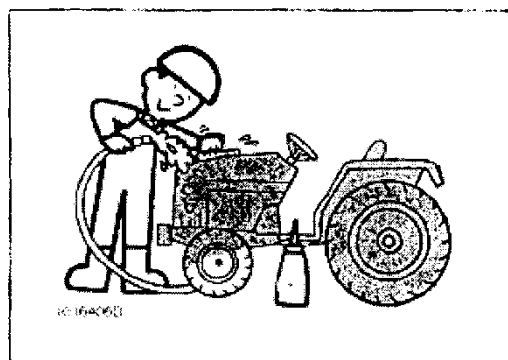

### 2. Opening the bonnet and side covers

#### Opening/closing the bonnet

##### Opening

- (1) Push down the bonnet lever (A) to release the bonnet lock.
- (2) Lift the bonnet and fix it with the stopper (B).

##### Closing

- (1) Lift slightly up the bonnet to unlock the stopper (B); mount the stopper (B) in the clip.
- (2) Lower the bonnet and press it down until a click is heard.

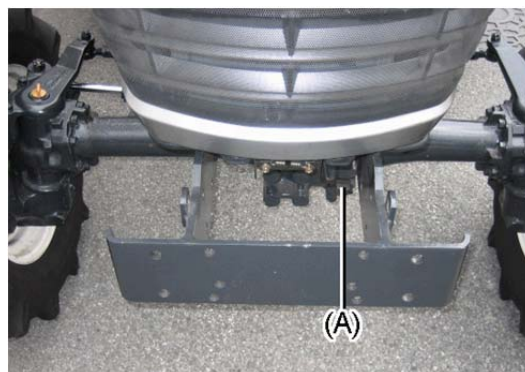



## Removing/mounting the side covers

### Removing

- (1) Open the bonnet.
- (2) Put the locking knobs in the vertical position (each forward and rear).
- (3) Remove the side covers.

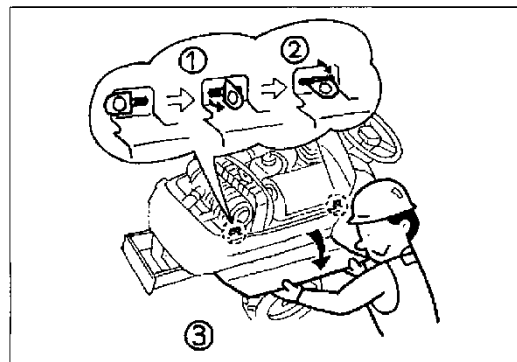

### Mounting

- (1) Clamp the cover lower hooks (x 2).
- (2) Fix the cover top with the locking knob.



## 3. Checking and supplying fuel



### DANGER

- Never smoke during re-fueling.
- Never use a bare lamp/light during re-fueling.
- After adding fuel, be sure to fasten the fuel cap and clean off the fuel spill.
- Never refuel while the engine is running or still hot after stopping. A fire can result.

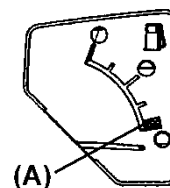

Set the main key switch to ON. If the fuel gauge reads in the red region, open the fuel cap and add the fuel.

- (A) Red region  
(B) Fuel cap

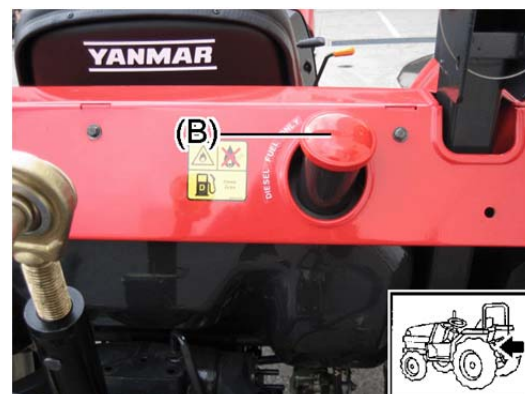

## 4. Care for long period of storage

### WARNING

For stowage over a long period of time, remove the battery from the tractor and remove the main key. Otherwise, an accident may occur.

### CAUTION

Lock the clutch pedal for stowage over a long period of time. Otherwise, an accident may occur.

If the tractor is not to be used over a lengthy period of time, take the following maintenance:

- (1) Place the tractor in a well ventilated place and remove the weight or other attachments. Remove the implement or lay it down on a wooden plate.

(A) Good ventilation

- (2) Coat the exposed metallic parts with anti-rusting oil, engine oil or grease.
- (3) Fill the tank with fuel oil. Otherwise, moisture will develop in the tank and cause rust. Put the fuel cock in the CLOSE position.

- (4) Fully charge the battery. It is recommended to detach the battery from the tractor and keep it in a dark cool place. If the battery is kept on the main body, disconnect the ground line (negative lead).
- (5) Remove the cooling water.
- (6) Cover the opening of the air cleaner, muffler or engine oil port with a polyethylene bag or the like to prevent the moisture from getting in.
- (7) To prevent the clutch from being rusted, fully depress the clutch pedal and put on the clutch pedal lock.
- (8) Fill the front and rear tires with air to normal pressure.

The periodic check and inspection during stowage over a long period will ensure the preferable conditions of your tractor.

#### NOTE:

The battery is subject to self-discharge. Fully charge it up at least once a month.

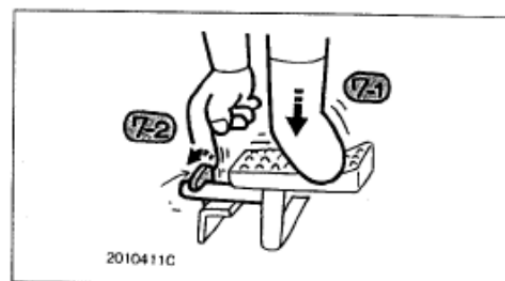
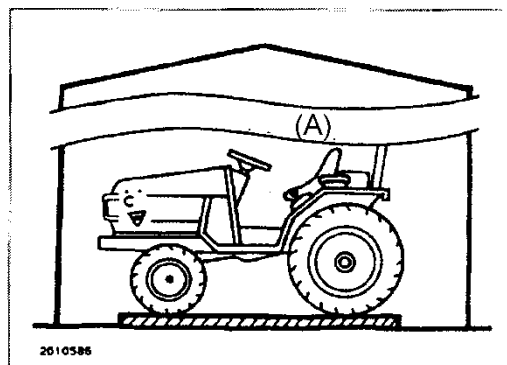

## PERIODIC INSPECTION AND ADJUSTMENT



### WARNING

Check or maintenance should be done with the tractor fixed on the flat ground, free from normal traffic. Pay attention not to topple the tractor. Put blocks to the wheels.



### CAUTION

- Do the periodic check and inspection every year. Replace the fuel pipes and power steering hoses every 2 years. Otherwise, an accident or machine damage may result.
- Never fail to stop the engine before commencing checks and service.
- Remount the covers which have been removed for maintenance. The revolving parts may catch a person nearby leading to a serious injury.

Periodic inspection and maintenance in off-season will ensure the preferable conditions of your tractor. To keep your machine working in good conditions, ask your service shop for a regular inspection every year.

It is recommended to replace fuel pipes, rubber hoses, and electrical wires every two years.



### IMPORTANT

- Only use the Yanmar genuine parts. Otherwise, service accidents can result.
- We recommend the use of the Yanmar lubricants that are available from your local Yanmar dealer.

## 1. Check intervals

x: Checks required

CHECK ITEMS	50 h	100h	150h	200h	250h	300h	350h	400h	450h	500h	550h	600h
Engine lubrication oil	Replace	Replace		Replace		Replace		Replace		Replace		Replace
Engine oil element	Replace					Replace						Replace
Transmission oil	Replace	X	X	X	X	Replace	X	X	X	X	X	Replace
Line filter (Hydraulic)	Replace					Replace						Replace
Transmission oil strainer	Clean					Clean						Clean
Fuel filter						Replace						Replace
Water separator	Drain	Drain		Drain		Clean		Drain		Drain		Clean
Radiator interior	Clean the interior of radiator when replacing cooling water											
Cooling water	Check before every work / Replacing every year											
Front axle oil	Replace	X	X	X	X	Replace	X	X	X	X	X	Replace
Air cleaner element	X	X	X	X	X	Replace	X	X	X	X	X	Replace
Radiator screen	X	X	X	X	X	X	X	X	X	X	X	X
Clean cooling fan, radiator	X	X	X	X	X	X	X	X	X	X	X	X
Battery liquid level	Check before every work											
Battery liquid gravity		X		X		X		X		X		X
Fuel piping, connections	X	X	X	X	X	X	X	X	X	X	X	X
Rubber hoses (Power steering)	X	X	X	X	X	X	X	X	X	X	X	X
Radiator hoses	Replace hoses every two years											
Hydraulic rubber hoses	Replace hoses every two years											
Fuel pipe, electric wires	Replace pipes and wires every two years											
Electric wiring, connections	X	X	X	X	X	X	X	X	X	X	X	X
Greasing	X	X	X	X	X	X	X	X	X	X	X	X
Greasing, propeller shaft										Apply		
Fastening of steering wheel fix nut		X		X		X		X		X		X
Important nuts and bolts	X	X		X		X		X		X		X
Cooling fan belt	X	X		X		X		X		X		X
Engine breather pipe	X	X	X	X	X	X	X	X	X	X	X	X
Engine crank case												X
Clearance of exhaust valve												X
Fuel injection valve												X
Generator, start motor	X	X				X				X		
Hydraulic system	X	X				X				X		
Fixing bolts of tires	X	X		X		X		X		X		X

Break-in period is 50 hours. If not reached, take up 1 year instead.

Items marked "Replace" should be replaced every two years even before suggested time intervals.

Replace the power steering hoses every 2 years.

## 2. Oil and grease

OIL, GREASE	TYPE
Fuel	Diesel fuel only
Engine oil	SAE 30 or 40 API Grade CD or better
Grease	Multipurpose Grease
Transmission oil, Hydraulic system oil	TF-500 Transmission fluid

\* At temperature below – 10°C, use Super No.3 light oil.

## 3. Oil and water volume

(Unit: liters)

		EF453T	OIL TYPE
Fuel		40	Diesel light oil
Cooling water	Radiator	4	Anti-rusting fluid
	Sub-tank	0.45	Anti-rusting fluid
Engine oil		5.3	SAE 30 or 40
Transmission oil		27	TF-500A Transmission fluid
Front axle oil		7.5	TF-500A Transmission fluid, SAE 90

## 4. Replacing oil



### DANGER

Never add oil while the engine is warm or running.  
A fire may occur.



### CAUTION

Never add oil just after stopping the engine. You may be burned.

### Engine oil

#### Check

Draw out the oil gauge on the right side of the engine and wipe off oil with a cloth. Reinsert and remove it again to see if the oil level is within the upper and lower marks.

If insufficient, add the new oil as much as the normal level through the supply port.

- (A) Oil gauge
- (B) Oil supply port

#### NOTE:

Check the oil level before the engine starts or when the engine is cool.

#### Replacing oil

Remove remaining oil through the drain plug on the lower part of the engine. Add the new oil through the oil supply port. Select a proper type of engine oil and replace it periodically considering the temperature and operating conditions.

- (A) Drain plug

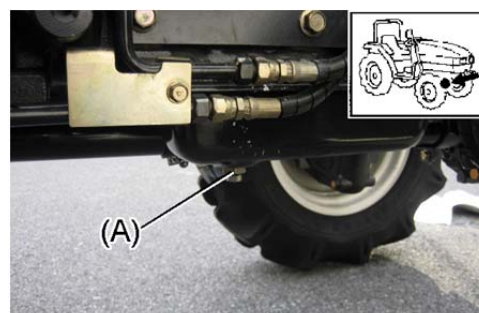
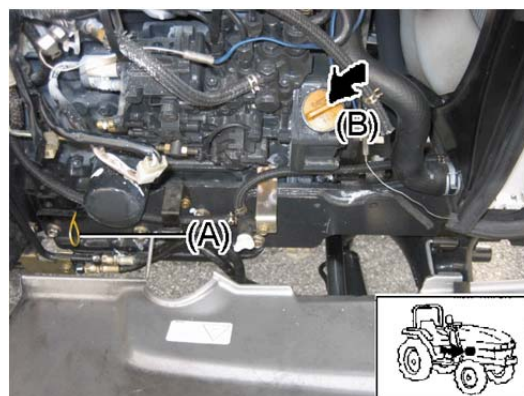

## Transmission oil

### Check

Draw out the oil gauge on the rear part of the transmission and check the oil level. The level should be between the upper and lower limits. If insufficient, add the new oil to the normal level. Also check for leaks.

- (A) Oil supply port
- (B) Oil gauge

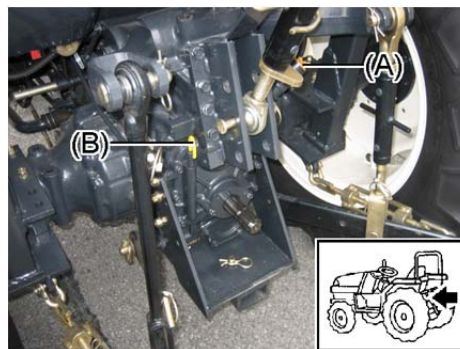

### Replacing oil

Remove the remaining oil through the drain plugs on the bottom of the transmission case. Removal is easy if the transmission case is warm. Add the new oil through the supply port on the rear part.

- Transmission oil is commonly used with hydraulic oil and power steering oil.
- Use Yanmar transmission fluid TF-500 or equivalent for transmission oil.

- (A) Drain plug

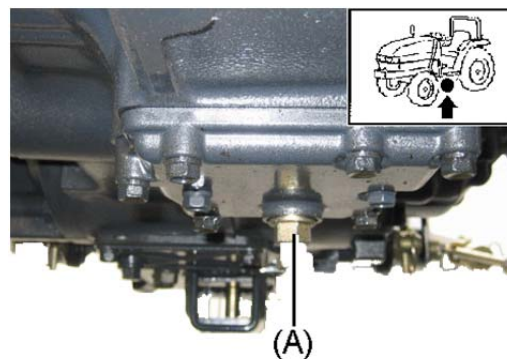

### Cleaning transmission oil strainer

When replacing transmission oil, wash the oil strainer with diesel fuel.

- (A) Oil strainer

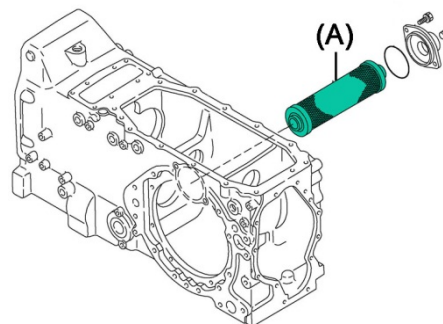

### Equivalent to TF-500A

SUPPLIER	BRAND NAME
Mobil	Mobil Fluid 425, 424
Castrol	Agricastrol MP, CASTROL UTF
Shell	Tellus Oil 32 or 37, Donax TD
Ford	ESN-M-2C-134A
Esso	Torque Fluid 56
John Deere	J20B, J14A
BP	Tractran UTH

## Front axle oil

### Check

Remove the oil gauge plug on the top of the front axle. Wipe off the gauge rod and reinsert it without screwing. Redraw it and see if the oil level is within the upper and lower marks. If insufficient, add the new oil through the oil supply port to the normal level. Check also for oil leak.

- (A) Oil gauge plug
- (B) Oil supply port

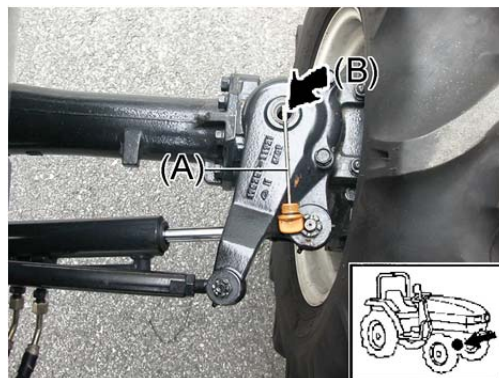

### Replacing oil

Remove oil through center drain plug on the lower part of the front axle and drain plugs on the bottom of the right and left gear cases. Add oil through the right port.

Use Yanmar TF500A transmission fluid, or carrier red 80B, or equivalent for front axle oil.

- (A) Center drain plug
- (B) Gear case drain plug

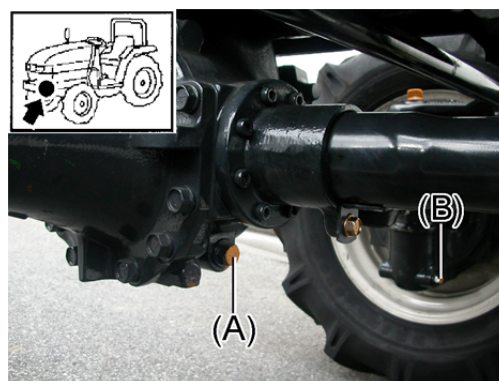

## 5. Replacing oil filter elements

### Engine oil element

Replace the engine oil element at intervals of **300 hours** or every 2-3 times of replacing the engine oil.

- (A) Turn left to detach
- (B) Oil element

### Replacing oil

- (1) Remove engine oil and turn the cartridge anticlockwise with a filter wrench.
- (2) Apply a slight coating of oil on the rubber ring on the bottom of the new cartridge. Mount the cartridge with a filter wrench.
- (3) After replacing the engine oil, run the engine until the **engine lubricating oil lamp goes off.**
- (4) **When the engine lubricating oil lamp goes off,** again check the oil level with the gauge. If insufficient, add the oil.

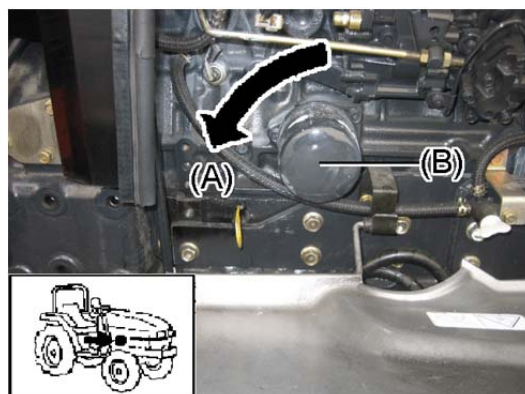

## Line filter (Transmission oil element)

The line filter is of a cartridge type. Replace it with a new one at intervals of **300 hours** thence.

(A) Line filter

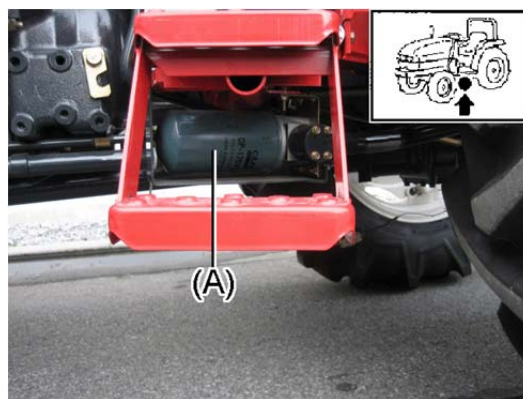

### Replacement

- (1) Remove the transmission oil and remove the cartridge by turning it anticlockwise.
- (2) Apply a slight coating of oil on the rubber ring on the bottom of the new cartridge. Mount the cartridge securely.
- (3) After replacing the transmission oil, idle the engine and check the oil level with an oil gauge. If insufficient, add the oil.

## 6. Engine coolant



### DANGER

Never open the radiator cap when the engine is hot. Hot steam and boiled water may blow out and you may suffer severe burns.

### Check

Open the bonnet and check water level in the sub-tank whether water is between "FULL" and "LOW" marks. If water is insufficient, remove sub-tank cap and add clean water.

Be sure to close the sub-tank cap firmly.

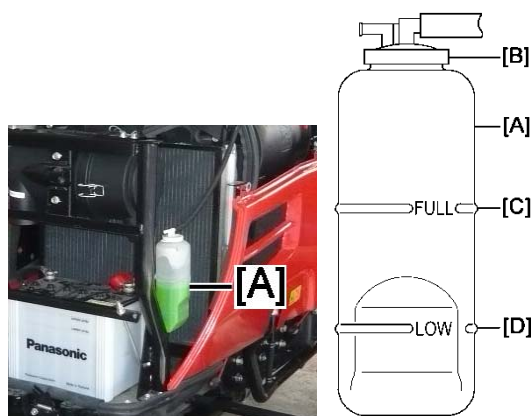

- [A] Sub-tank
- [B] Sub-tank cap
- [C] Upper limit (FULL)
- [D] Lower limit (LOW)

### Replacing coolant

- (1) Remove the coolant drain plug and drain cooling water. It is easier for draining to open radiator cap.
- (2) Clean the inside of radiator with tap water until dust or rust does not come out.  
It is suggested to use radiator detergent. Fill radiator with water and detergent and run the engine in idle speed for more than 15 minutes. Drain the water.
- (3) Fill radiator with clean water.  
It is recommended to mix anticorrosive. Run the engine for about 5 minutes in idle speed to mix water and anticorrosive.

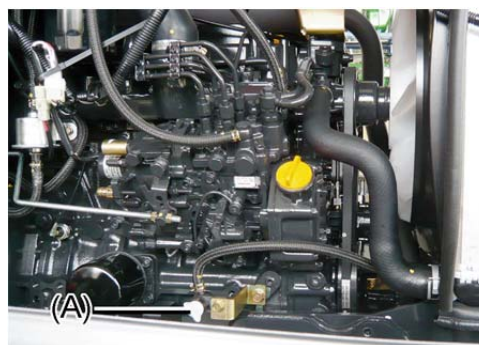

(A) Coolant drain plug



### IMPORTANT

The mixing ratio of anticorrosive varies depend on manufacturer. Follow the instruction of its manufacturer.



## 7. Fuel line

### Fuel filter

Replace fuel filter every **300 hours**.

### Replacing

- (1) Close fuel cock on water separator.
- (2) Remove the cartridge by turning anticlockwise.
- (3) Apply a little oil on the rubber ring on the new cartridge. Mount the cartridge by hand first and tight it with filter wrench.
- (4) Open the cock and bleed the air from the fuel.



### IMPORTANT

**Use genuine element. Otherwise, FIE (Fuel Injection Pump) will be in trouble, premature wearing of plunger. It may cause a hard start of the engine.**

### Water separator

#### Removing water from water separator

The water separator separates water from fuel oil. Water accumulates in the fuel tank by formation of dew. The water in fuel may damage the fuel injection pump when the water gets in the plunger and barrel.

Drain the water accumulated in the water separator regularly, every **100 hours** or shorter if much water in the bowl.

- (1) Remove the cover [A].
- (2) Turn the fuel cock (2) to (b) to close.
- (3) Turn the drain cock (4) to drain the water.

- [A] Cover  
[B] Water separator  
(2) Fuel cock  
(4) Drain cock  
(b) Close

#### Cleaning water separator element

Clean the element regularly, every **300 hours** or shorter when it gets dirty.

- (1) Turn fuel cock (2) to (b) to close the fuel cock.
- (2) Turn retaining ring (5) to remove ring and detach water separator bowl.
- (3) Clean strainer (3), inside of bowl.
- (4) Reinstall strainer, bowl and retaining ring.
- (5) Turn fuel cock to (a) to open the fuel cock.

#### NOTE:

Strainer is made of plastic and be careful not to damage. It is suggested to clean it with used toothbrush or soft brush. If strainer was damaged, replace it with a new genuine part.

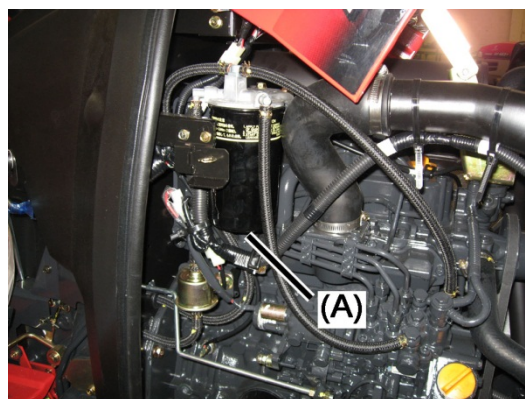

(A) Fuel filter

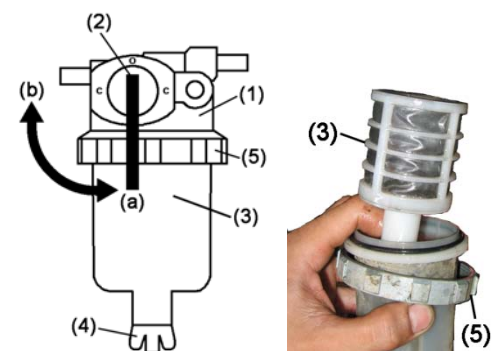
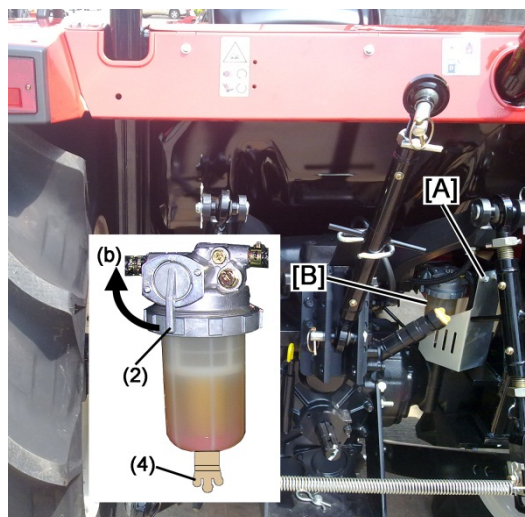

- (1) Water separator  
(3) Strainer  
(5) Retainer ring  
(a) Open  
(b) Close  
(2) Fuel cock  
(4) Drain cock

## 8. Replacing radiator screen and air cleaner elements

The air cleaner serves to keep the engine in favorable conditions by removing dust in air and preventing the cylinder liner and piston ring from wearing.

For operation in a dusty environment, clean the air cleaner element every 50 hours and replace it every 300 hours.

For operation in a normal condition, clean it every 100 hours and replace it every 1000 hours. Even before the said intervals, replace it every year.

### Cleaning air cleaner element

- (1) Open the bonnet.
- (2) Remove the sub tank.
- (3) Open the lid and take out the element.

- (A) Air cleaner (Outer)
- (B) Air cleaner (Inner)

- (4) Blow air from inside of the element or lightly pat it to take off dust. Be careful not to damage the fins.



### IMPORTANT

When the inner element (B) is dirty, replace it. It cannot be cleaned.

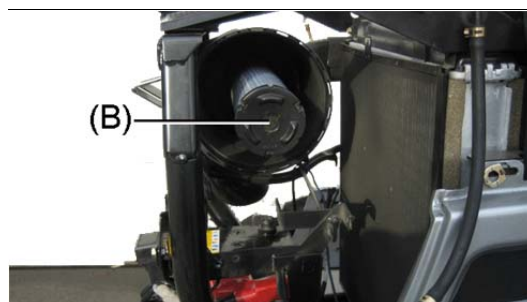
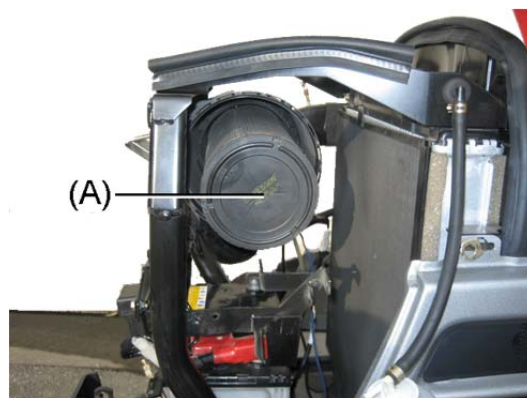

### Cleaning radiator screen

Pull the radiator screen upward and remove straws and dust from it.

- (A) Radiator screen



## 9. Checking battery



### DANGER

- Never use a fire while checking the battery or the battery cap is removed. Otherwise, a fire or gas explosion may result.
- Do not come in contact with the battery fluid. If the fluid attaches on your body or cloth, immediately wash out with water. Otherwise, you may be burnt.



### CAUTION

To mount the battery, start with the positive lead (+). For removal, start at the negative lead (-). Otherwise, a short circuit will burn you.

### Check battery

Check the level of battery electrolyte whether it is between upper and lower limit line.

If the level is lower than the lower limit, add distilled water as high as the upper limit.

- (A) Battery
- (B) Upper limit
- (C) Lower limit

#### NOTE:

- Excessive battery fluid may overflow during recharging, damaging the metallic parts of the tractor.
- Add distilled water only. Adding battery electrolyte, such dilute sulphuric acid, may shorten the battery life.
- Quick charge is not recommended.
- When replacing the battery, use the specified battery.

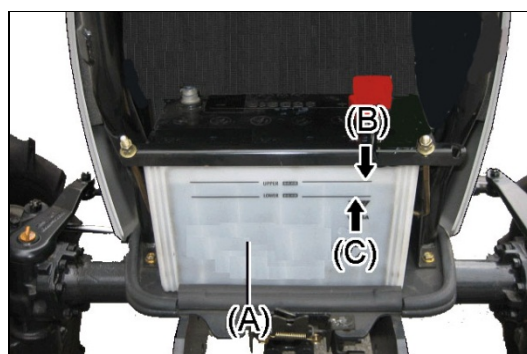

### IMPORTANT

- Make sure the tractor is level when checking the level of electrolyte.

### Removing and installing battery

#### Remove

- (1) Open the bonnet
- (2) Disconnect the negative (ground) cable from the battery and disconnect the positive cable.
- (3) Loosen fixing nuts and remove the battery.

#### Installation

- (1) Connect positive cable and negative cable.
- (2) Tighten fixing nut.

- (D) Negative (ground) cable
- (E) Positive cable
- (F) Fixing nut

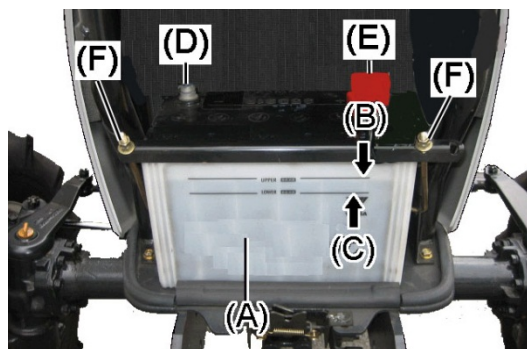



## IMPORTANT

- Be sure the tractor is level when checking electrolyte level.
- When connecting the battery cables, wipe oil away from the terminal contacts. After connecting cables, apply grease to the terminals.
- Be sure to attach the rubber boots for the positive terminal of the battery.
- When replacing the battery, be sure to use the genuine battery or equivalent specified in the right table.
- For environmental protection and recycle of resources, return the old battery following the regulation of your place.

### Battery type

Specified battery	Parts code No.
75D26R	1A7781-51510

Voltage	12Volts
Capacity 5HR	52AH
Charging rate	11 Amperes

## 10. Checking fluid lines



### CAUTION

Aged or damaged pipes are subject to fuel leak which will cause a fire. Check for a leak and replace the pipe with new one.

Check the power steering pipes, fuel pipes and radiator hoses for leak or loose couplings. Replace them every two years, damaged or not damaged.

- (A) Radiator hose
- (B) Fuel pipe
- (C) Power steering pipes

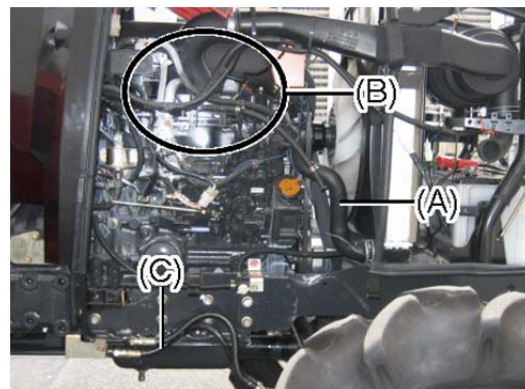

### NOTE:

Bleed the air after the fuel pipe has been replaced.

## 11. Checking electrical wiring



### WARNING

- Check before starting day's work that the cables are not short circuit to other parts or insulator is not damaged, or contacts are not loosened.
- Remove straws and dust from the cables and joints before starting works. Otherwise, a short circuit can cause a fire.

Remove the engine side cover and check the electrical wires for damaged sheaths or loose connections. Repair them or consult your service representative.

Check them every 50 hours or every year.

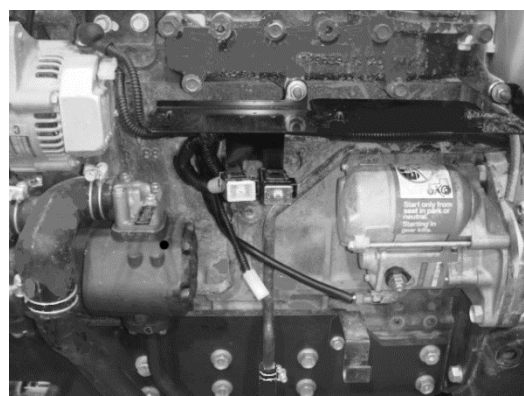

## 12. Greasing

Before initiating day's work, check the greasing condition at each point. Grease up after a work on a muddy field. As a general rule, grease up various points at intervals of 50 hours.

- (A) Brake pedal shaft
- (B) Tie rod
- (C) Power steering rod
- (D) Front center pin
- (E) Clutch pedal shaft
- (F) Range shift lever

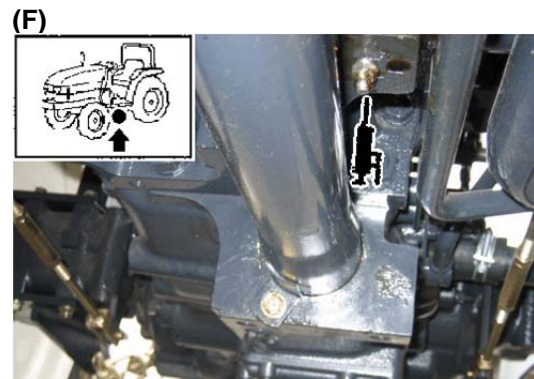
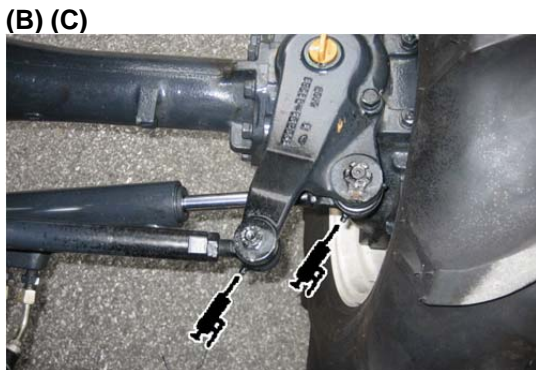
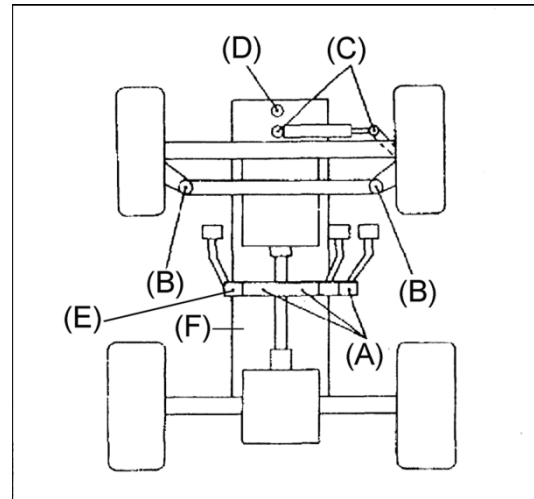

## Lubricating propeller shaft with grease

Lubricate the propeller shaft connection with grease every 500 hr. When working in the wet field, shorter lubrication intervals are suggested.

### 1. Front end

- (1) Loosen the band (A).
- (2) Remove the bolt (B) and the collar (C).
- (3) Slide the front shaft cover (D) backward as the right picture shows.

- (A) Band
- (B) Bolt
- (C) Collar
- (D) Front shaft cover

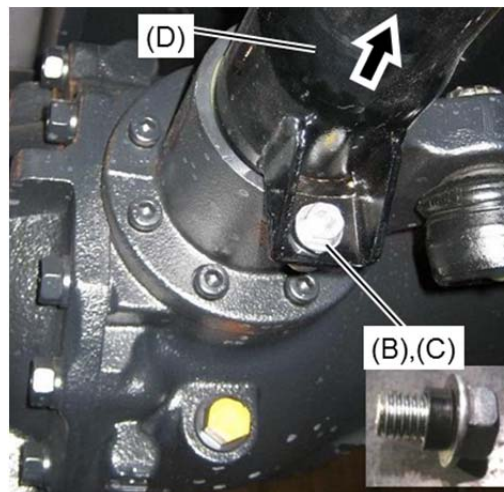
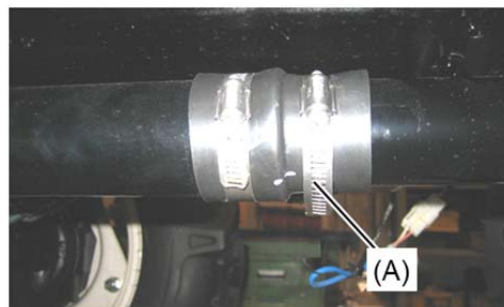

- (4) Turn over the rubber boots (E) as the right illustration shows.
- (5) Slide the coupling (F) backward as the right illustration shows.  
※Be careful not to lose ball (G).
- (6) Apply enough multipurpose grease to six balls (G).
- (7) Turn back the rubber boots (E) to their original position.
- (8) Fix the front shaft cover (D) to front axle support with bolt (B) and collar (C).  
※Be sure to install collar (C). If not, the front shaft cover may be broken in a short time.

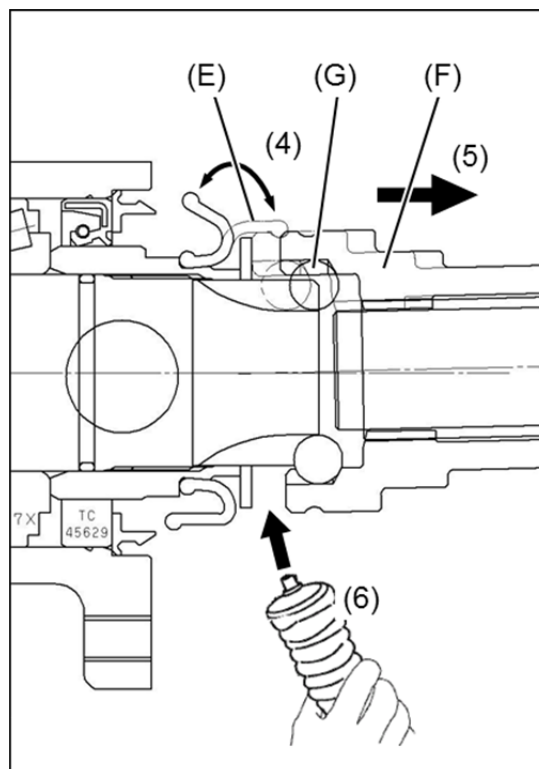

## 2. Rear end

- (1) Remove the bolt (B) and collar (C) from rear shaft cover (H).
- (2) Slide the rear shaft cover (H) backward as the right picture shows.

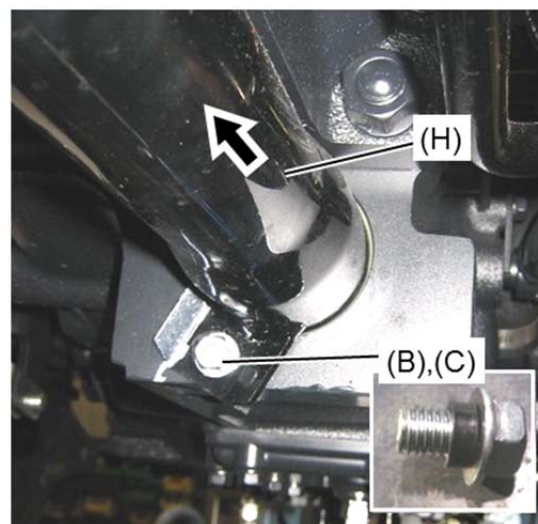

- (3) Turn over the rubber boots (E) as the right illustration shows.
- (4) Slide the coupling (F) forward as the right illustration shows.  
※Be careful not to lose ball (G).
- (5) Apply enough multipurpose Grease to six balls (G).
- (6) Turn back rubber boots (E) to their original position.
- (7) Fix the rear shaft cover (H) with bolt (B) and collar (C).  
※ Be sure to install the collar (C). If not, the rear shaft cover may be broken in a short time.
- (8) Tighten the band (A).

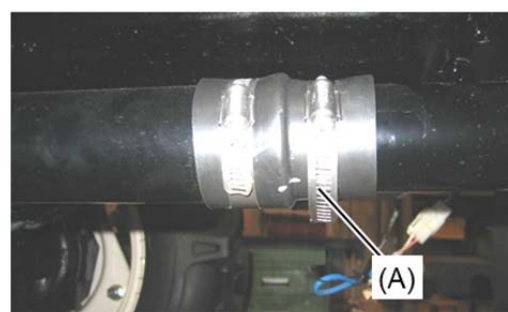
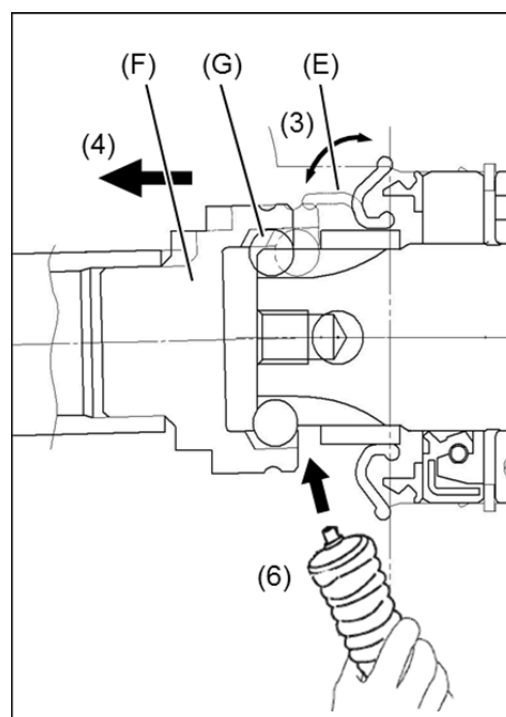

### 13. Adjusting brake



#### WARNING

- Check if the brake is effective or not one-sided. An accident can result.
- Unbalanced play at left and right brake pedals can cause one-sided braking effect. Keep the same amount of play; otherwise, an accident can result.

Depress the brake to see a required play of 30-40 mm is available and if the left and right pedals work together. If not, adjust the turnbuckles behind the pedals for a play of 30 mm. Secure the turnbuckle with the lock nuts. Make sure the parking brake lock is put on when the brake pedals are fully stepped in.

- (A) Play 30-40 mm  
(B) Turn buckle



#### Right brake

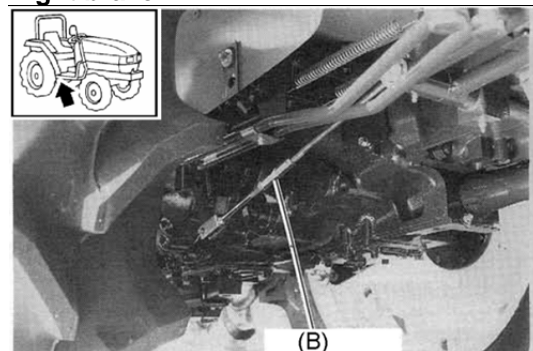

#### Left brake

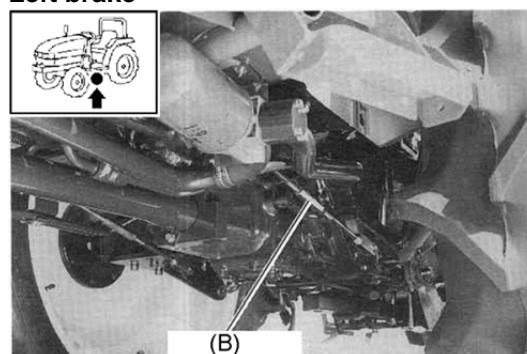



## 14. Adjusting clutch

Standard version

Depress the clutch pedal to see if there is a specified play of 15-25 mm. If not, adjust the turnbuckle for a play of 15-25 mm. Securely lock the nut after adjustment.

- (A) Play 15-25 mm
- (B) Turn buckle

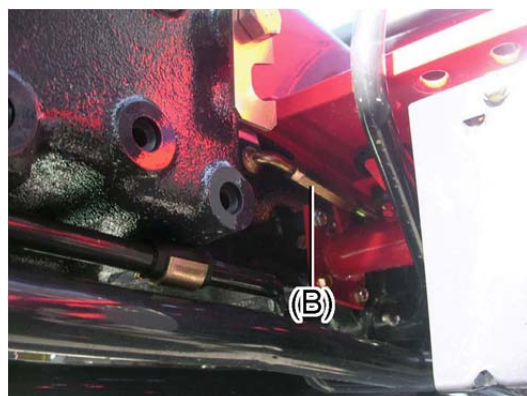
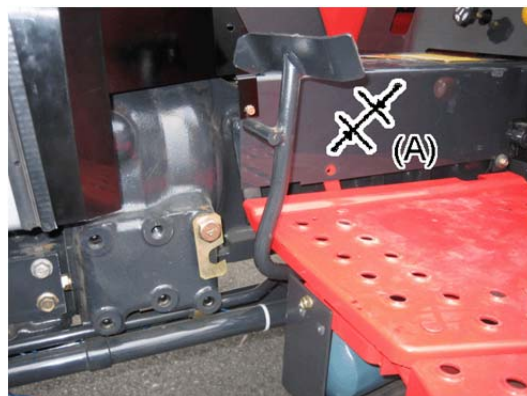

## 15. Adjusting steering wheel



### WARNING

Check a play for the steering wheel. It should be within a tolerable range. Otherwise, an accident may occur.

Turn the steering wheel slightly left and right to see if there is a play of 20-50 mm. Improper play will fail to provide the smoothness and linearity of steering function. If a play is not adequate, contact your service representative.

- (A) Play

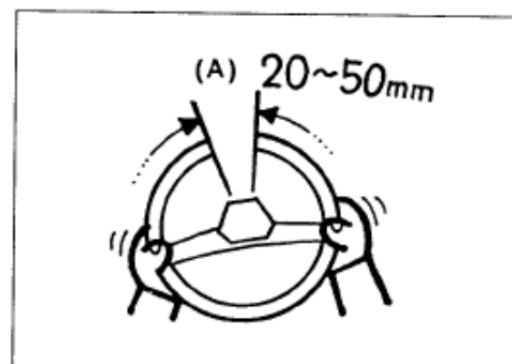

## 16. Adjusting fan belt



### CAUTION

Wait until the engine is sufficiently cooled down. Otherwise, you may be burned.

- (1) Switch off the engine.
- (2) Open the bonnet, then the left side cover of the engine.
- (3) Press the fan belt with a finger at the midpoint to see the belt deflections 10-15 mm.
- (4) If not, loosen the alternator fastening bolt and shift the alternator to adjust the belt tension.

If the belt still slips after full shift of the alternator, replace the belt with a new one. Check the new belt at intervals of 50 hours.

- (A) Alternator
- (B) Alternator fastening bolts
- (C) Fan belt

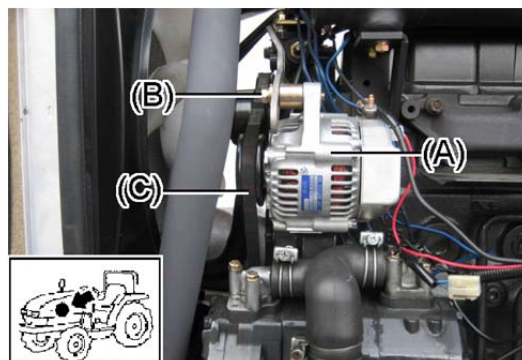

## 17. Adjusting tow-in

Poor adjustment of tow-in will result in an abnormal steering performance. Measure the front wheel dimension A and B. The difference of A-B should be 4-8 mm. If out of this range, loosen the lock nut of the tie rod end and adjust the turnbuckle. Fasten the lock nut where the tow-in is 4-8 mm.

- (A) Front
- (B) Tie rod
- (C) Lock nut

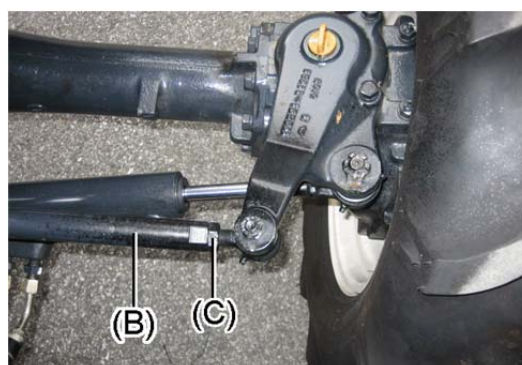
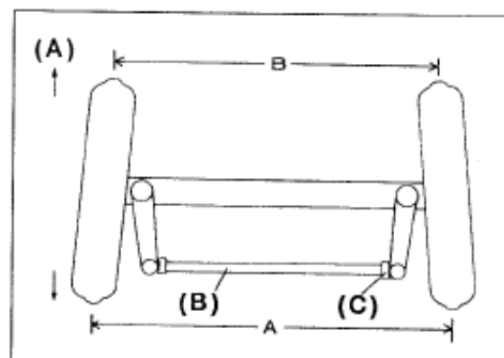

### 18. Replacing fuse

Remove the lid of the fuse box and check the fuse.  
 Replace the blown fuse with new one.  
 Stop the engine and check the main fuse (slow blow fuse) which shuts off the electrical circuit when an excessive current flows. Fused condition can be checked by the changed color of the outer sheath.

(A) Fuse box



- START : Starter motor 5A
- WORK : Working light 5A
- TURN : Turn signal light 5A
- TAIL : Tail light 5A
- HEAD : Head light 15A
- HORN : Horn 5A
- FUEL : Fuel pump 5A
- ENG : Timer relay 5A
- IND : Indicator light 5A

START		WORK	TURN	TAIL	SPARE	SPARE	1A7780-65470
5A		5A	5A	5A	5A	15A	
HEAD	HORN	FUEL	ENG	IND		PULLER	
15A	5A	5A	5A	5A			

- (A) Main fuse: 60A
- (B) Alternator fuse: 60A

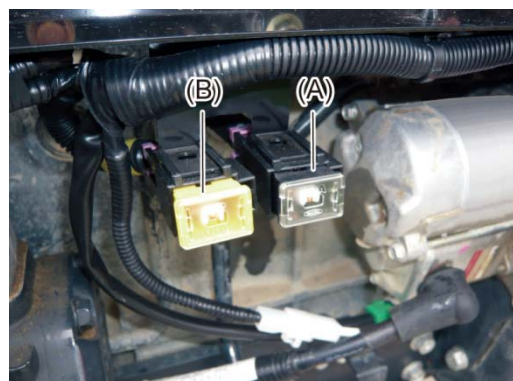

## 19. Checking tires

Adjust the air pressure of front and rear tires to the standard pressure. Check the tires for cracks or damage. Adjust the front tire pressure for a maximum in the following table if a load is to be imposed on the front tires through the front weight or front loader.

<u>Air pressure (kg/cm<sup>2</sup>)</u>	
Front tire	2.4
Rear tire	2.0

Fastening torque (Front and rear)

Fixing bolts for wheel and axle shaft:  
186 N-m (19 kgf-m)

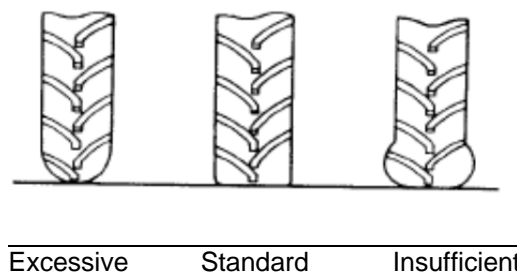

## 20. Color of exhaust gas

The color of exhaust gas is black when the engine is started and gray during normal operation.

Black: Incomplete combustion due to dense fuel  
White: Engine oil is burning. Normal exhaust may look white at extremely low temperature.

If exhaust gas is black or white without a load on the tractor, consult your service representative.

## TROUBLESHOOTING

In case of abnormality of machine, stop the engine and locate a problem by referring to the following table.

### 1. Engine parts

PROBLEM	POSSIBLE CAUSE	RESPONSE
Won't start by main switch	Shift lever in N?	Set each shift levers in N. Under this condition, turn the main switch to START.
	Is battery liquid at normal level? Battery nor discharged?	Add the battery liquid to the normal level. Charge the battery.
	Check the battery terminals for looseness or rust.	Clean and fasten the terminals. Apply grease coating to avoid rusting.
	Main fuse blown	Replace the fuse with new one.
	Switch trouble	Have it repaired by the service representative.
	Starter trouble	Have it repaired by the service representative.
Self-starter running but the engine fails to start	No fuel	Add the fuel and remove air.
	Air in the fuel	Remove air from the fuel.
	Fuel cock in the C position	Put the fuel cock in the 0 position.
Engine runs irregularly	Air in the fuel supply system	Bleed air.
	Water mixed in the fuel	Remove water and replace with light oil
	Jet nozzle clogged	Replace or repair the nozzle.
	Clogged fuel filter	Clean or replace the filter element.
Engine overheating	Lack of cooling water	Add cooling water.
	Loosened or damaged fan belt	Adjust the tension of belt or replace the belt with new one.
	Clogged radiator fins	Clean the radiator fins.
	Running out of engine oil	Add engine oil.
	Overloaded	Reduce the load.
Low engine power	Clogged air cleaner	Check the air cleaner.
	Burnt nozzle	Have it repaired by the service representative.
	Low compression	Have it repaired by the service representative.
	Valve clearance incorrectly adjusted	Have it repaired by the service representative.
	Incorrect timing of fuel jet	Have it repaired by the service representative.
Oil pressure lamp lighting	Lack of engine oil	Add engine oil to the normal level.
	Low engine oil viscosity	Use the oil with adequate viscosity.
	Damaged pressure switch	Replace the switch.
	Damaged oil pump	Have it repaired by the service representative.
Charge lamp lighting	Damaged alternator	Have it repaired by the service representative.
	Loosened or damaged fan belt	Adjust the tension of the belt or replace the belt.

## 2. Clutch, brake and related parts

PROBLEM	POSSIBLE CAUSE	RESPONSE
Clutch not effective	Is pedal play proper?	Adjust the play of pedal.
Brake not effective or effective one sided	Is brake pedal play proper?	Adjust the play of brake pedal.
Brake pedal not returning quickly or it creeks	<b>Return spring is broken</b> Lack of grease in sliding mechanism	<b>Change the return spring.</b> Remove rust and apply grease.

## 3. Hydraulic system

PROBLEM	POSSIBLE CAUSE	RESPONSE
Impossible to raise the attachment implements	Hydraulic stop-slow turn valve and slow return valves are close.	Open the hydraulic stop-slow turn valve and slow return valves.
	Lack of transmission oil	Replenish oil to the normal level.
	Air is sucked through the suction pipe	Fasten the filter case and fittings. Replace damaged pipes or O-rings.
	Clogged oil filter	Clean or replace the oil filter.
	Damaged hydraulic pump	Have it repaired at your service representative.
	Dusty control valve. O-rings worn	Have it repaired at your service representative.
	Damaged cylinder	Have it repaired at your service representative.
Impossible to lower the attachment implements	Hydraulic stop-slow turn valves are close	Open the hydraulic stop-slow turn valves.
	Dusty control valve. O - rings worn	Have it repaired at your service representative.
	Damaged cylinder	Have it repaired at your service representative.

## 4. Electric system

PROBLEM	POSSIBLE CAUSE	RESPONSE
Headlight not lighting	Bulb blown	Replace the lamp.
	Fuse blown	Replace the fuse with new one.
	Disconnected wiring to the socket	Correct the wiring.
	Poor contact	Clean the terminals for better contact.
Flasher lamp not light	Bulb blown	Replace the lamp.
	Fuse blown	Replace the fuse with new one.
	Failure of flasher unit	Replace the flasher unit.
	Poor contact of flasher lines	Check connections of the earth line and termination.
Lamps not lighting	Bulb blown	Replace the lamp.
	Fuse blown	Replace the fuse with new one.
	Poor contact of supply lines	Check connections and correct them if necessary.
	Damaged switches	Replace the switches.
	Disconnected earth lead	Reassure the connection of earth lead to the body.
	Discharged battery	Recharge the battery.
Horn not working	Fuse blown	Replace the fuse with new one.
	Bad contact of horn lines	Check the horn line.

## SPECIFICATIONS

MODEL		EF494T	
Drive type		4-wheel Drive	
Dimensions	Overall length (mm)	3,230	
	Overall width (mm)	1,605	
	Overall height (mm)	2,355	
	Wheelbase (mm)	1,830	
	Tread	Front (mm)	1,300, 1,466
		Rear (mm)	1,270, 1,344
Ground clearance (mm)		375	
Weight (kg)		1,540	
Engine	Model	4TNV88	
	Type	4-cycle, water-cooled diesel	
	Output (SAE Gross) (HP/rpm)	49/2,800	
	Number of cylinders	4	
	Bore x Stroke (mm)	88 x 90	
	Displacement (cc)	2,189	
	Air cleaner	Dry, dual element	
	Fuel tank capacity (liter)	40	
Battery		12V-52AH	
Steering		Hydrostatic	
Clutch		Dry, single	
Brake		Mechanical, wet disc	
Transmission	Type	Collar shift	
	Gear shift (Forward x Reverse)	F9 x R9	
	Forward speed (km/hr)	1.6-28.8	
	Reverses speed (km/hr)	1.7-29.7	
	Max. speed, forward (km/hr)	30.8	
Tire	Front	8-18-6	
	Rear	13.6-26-8	
Rear PTO	Type	Transmission PTO	
	PTO shaft	SAE1-3/8 inch (35mm), 6 spline	
	Speed (rpm)	568, 769 at rated engine speed	
Hydraulic	Type	Position control	
	Hitch	3 point hitch, category SAE #1	
Draw bar hitch		Clevis type	

### NOTE:

All technical data, measurement and weight are approximate, and the manufacturer has the right to make alteration without prior notice.

### TRACTOR MASS AND TIRE SPECIFICATION

TIRE SIZE (Number of plies)		FRONT AXLE		REAR AXLE	
		Maximum working load of tires	Technically permissible mass on each axle	Maximum working load of tires	Technically permissible mass on each axle
F: 8-18(6), R: 13.6-26(8)	kg	650	980	1,580	1,675



### IMPORTANT

Set up the implement so that the front wheel load and the rear wheel load are not greater than the smaller of the following: the permissible load capacity of the tires or the technically permissible mass on each axle.

## IMPLEMENT CAPACITIES

The Yanmar tractor has been carefully tested in the configuration equipped with implements sold or approved by Yanmar and has proved to perform properly. Do not use any implement that has not been sold or recommended by Yanmar, or that fails to satisfy the specified values given below. Using with implements that are not approved by Yanmar could result in malfunction, failure, and damage to the tractor and/or implement, and increase the possibility of injury to the operator or other people. The Yanmar warranty does not cover any malfunction or failure that results from use of an unapproved implement.

	Lower link end maximum lifting capacity	Implement weight and size	Maximum drawbar load	Trailer loading weight maximum capacity
	W0	W1	W2	W3
kg	1,350	As specified in the implement capacity list	500	2,325

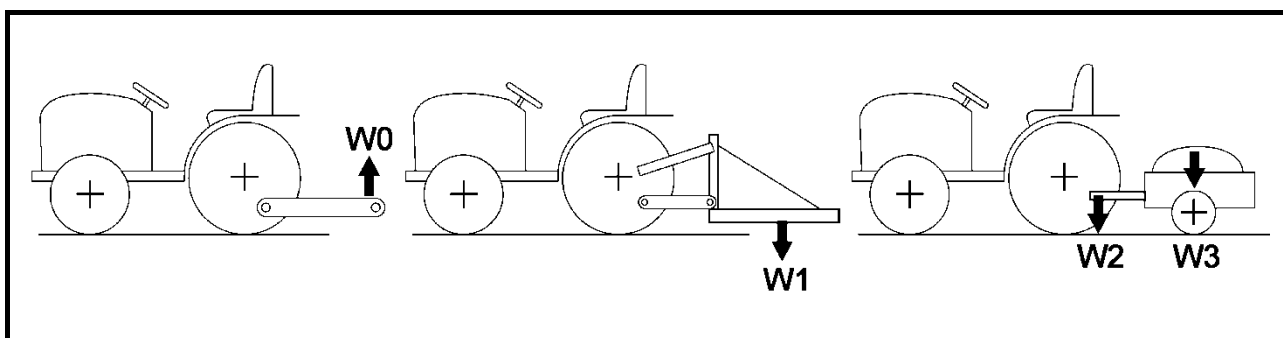

### Implement capacity list

Implement	Description	Unit	Maximum Amount
Rotary	Tilling Width	m	1.9
	Weight	kg	350
Disc plough	Disc Size(inch) & Total disc	Inch x disc	22X4, 24X3
	Weight	kg	300
Poly disc plough	Disc Size(inch) & Total disc	Inch x disc	22X6, 24X6
	Weight	kg	355
Front blade	Width	m	1.8
	Weight	kg	400
Sun roof	Weight	kg	35
	Length x Width	m	1620 x 1270
Grass cutter	Width	m	1.4
	Weight	kg	250
Trailer	Load Capacity	kg	2325
	Drawbar Load	kg	500
Front weight	Weight	kg	150
Rear wheel weight	Weight, one side	kg	60



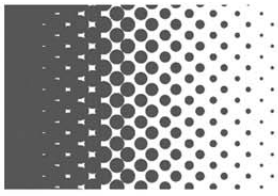

**DIESEL TRACTOR**

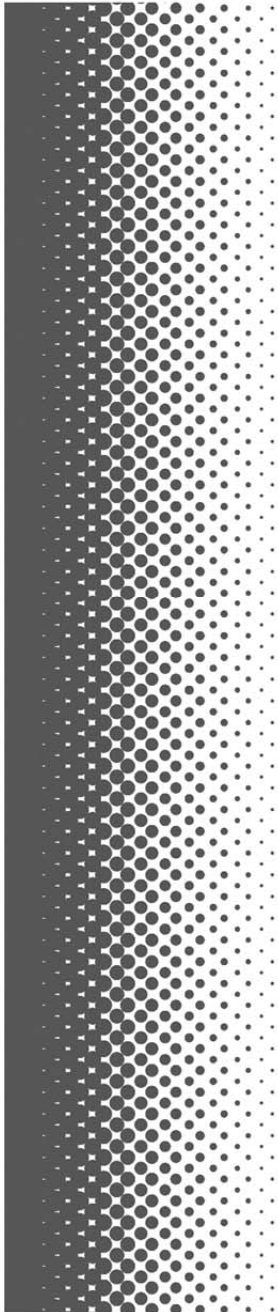

**YANMAR**

**YANMAR CO., LTD.**

<http://www.yanmar.com>

0A042-B00203